

**Revision E:**

- Detail of the indoor fan speed control in COOL or DRY operation has been added (9-1.3, 9-2.3).

Please void OBH515 REVISED EDITION-D.

# INDOOR UNIT SERVICE MANUAL

**No. OBH515  
REVISED EDITION-E**

## Models

<b>MSZ-GE22VA</b>	-	<b>E1</b>
<b>MSZ-GE25VA</b>	-	<b>E1</b>
<b>MSZ-GE35VA</b>	-	<b>E1</b>
<b>MSZ-GE42VA</b>	-	<b>E1</b>
<b>MSZ-GE50VA</b>	-	<b>E1</b>
<b>MSZ-GE60VA</b>	-	<b>E1</b>
<b>MSZ-GE71VA</b>	-	<b>E1</b>

Outdoor unit service manual  
**MUZ-GE·VA Series (OBH516)**  
**MXZ-A·VA Series (OB377)**  
**MXZ-8A140A (OC316)**  
**MXZ-B·VA Series (OB554)**

MSZ-GE22VA  
 MSZ-GE25VA  
 MSZ-GE35VA  
 MSZ-GE42VA  
 MSZ-GE50VA

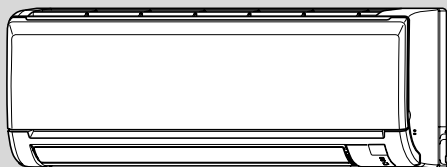

## CONTENTS

1. TECHNICAL CHANGES .....	3
2. PART NAMES AND FUNCTIONS .....	4
3. SPECIFICATION .....	5
4. NOISE CRITERIA CURVES .....	6
5. OUTLINES AND DIMENSIONS .....	8
6. WIRING DIAGRAM .....	9
7. REFRIGERANT SYSTEM DIAGRAM .....	10
8. SERVICE FUNCTIONS .....	11
9. MICROPROCESSOR CONTROL .....	13
10. TROUBLESHOOTING .....	20
11. DISASSEMBLY INSTRUCTIONS .....	39

**PARTS CATALOG (OBB515)**

**NOTE:**

RoHS compliant products have <G> mark on the spec name plate.



**Revision A:**

- 11. DISASSEMBLY INSTRUCTIONS has been corrected.  
11-6. Photo 9 has been changed.

**Revision B:**

- MSZ-GE42VA - [E1] and MSZ-GE50VA - [E1] have been added.

**Revision C:**

- MSZ-GE60VA - [E1] and MSZ-GE71VA - [E1] have been added.

**Revision D:**

- The model name for MSZ-GE25VA was added to 8-3. "AUTO RESTART FUNCTION".  
Because the model name was not written there.

**Revision E:**

- Detail of the indoor fan speed control in COOL or DRY operation has been added (9-1.3, 9-2.3).

# 1

## TECHNICAL CHANGES

**MSZ-GE22VA - E1**

**MSZ-GE25VA - E1**

**MSZ-GE35VA - E1**

**MSZ-GE42VA - E1**

**MSZ-GE50VA - E1**

**MSZ-GE60VA - E1**

**MSZ-GE71VA - E1**

1. New model

# 2

# PART NAMES AND FUNCTIONS

**MSZ-GE22VA MSZ-GE25VA MSZ-GE35VA MSZ-GE42VA MSZ-GE50VA**

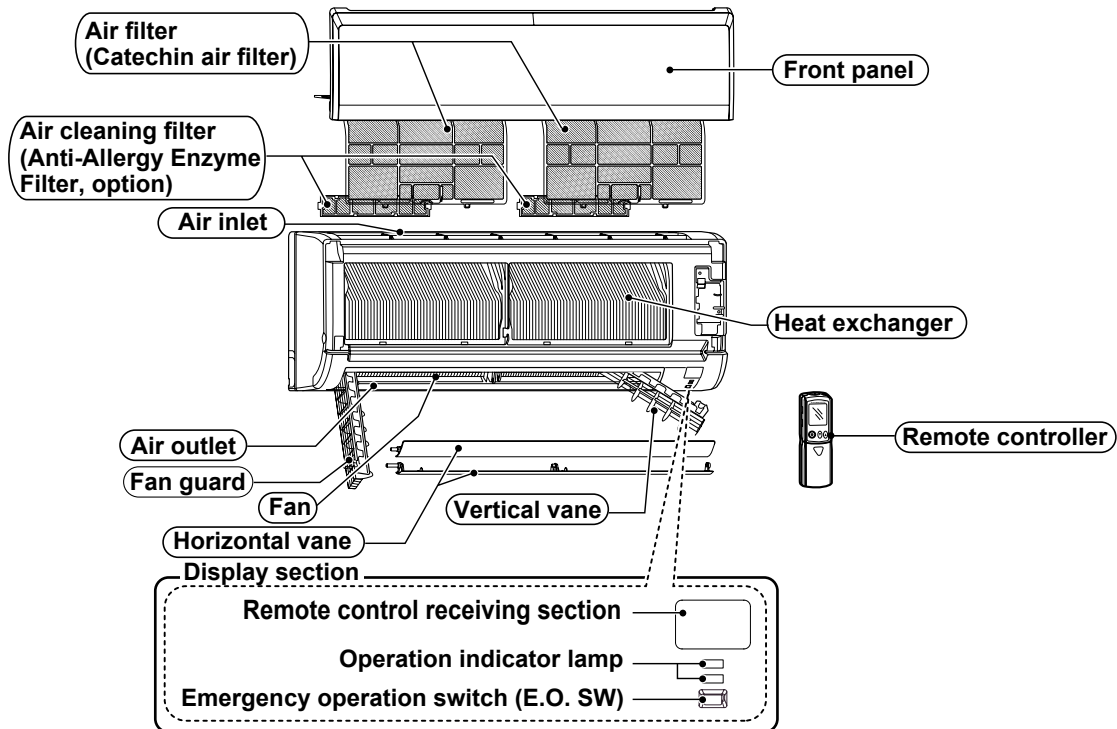

**MSZ-GE60VA MSZ-GE71VA**

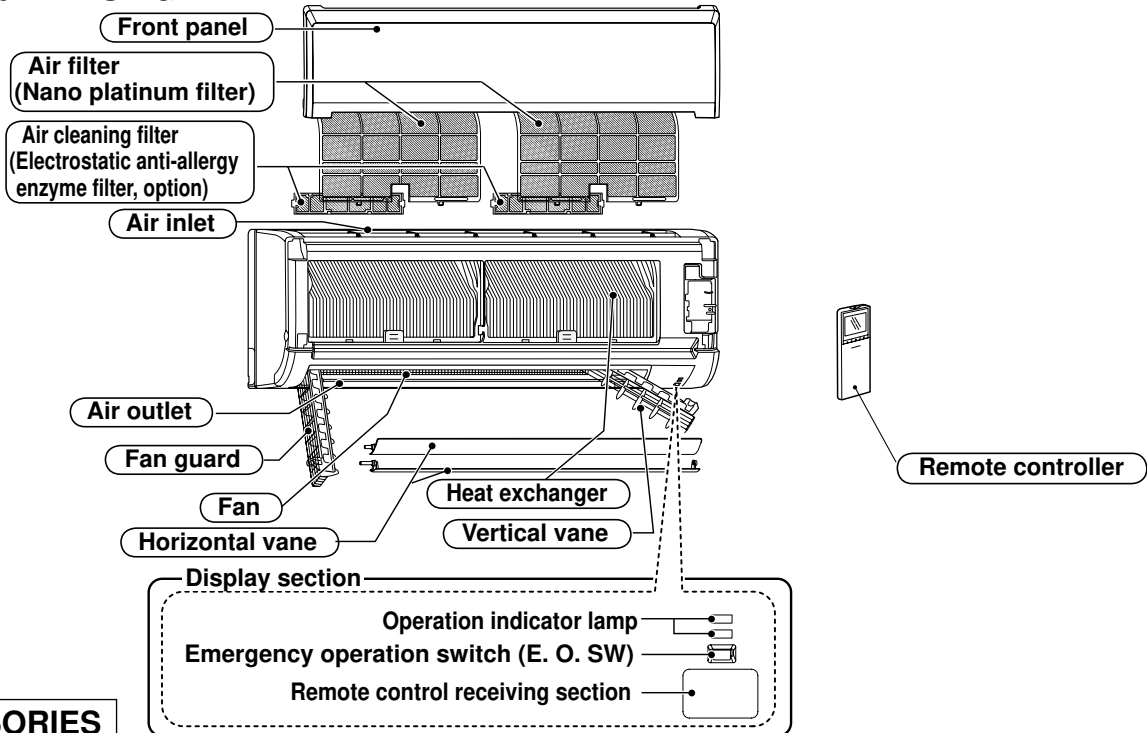

## ACCESSORIES

Model	MSZ-GE22VA MSZ-GE25VA MSZ-GE35VA MSZ-GE42VA MSZ-GE50VA	MSZ-GE60VA MSZ-GE71VA
① Installation plate	1	1
② Installation plate fixing screw 4 × 25 mm	5	7
③ Remote controller holder	1	1
④ Fixing screw for ③ 3.5 × 16 mm (Black)	2	2
⑤ Battery (AAA) for remote controller	2	2
⑥ Wireless remote controller	1	1
⑦ Felt tape (For left or left-rear piping)	1	1

# 3

# SPECIFICATION

Indoor model			MSZ-GE22VA	MSZ-GE25VA	MSZ-GE35VA	MSZ-GE42VA	MSZ-GE50VA	MSZ-GE60VA	MSZ-GE71VA		
Power supply			Single phase 230 V, 50 Hz								
Electrical data	Power input *1	Cooling	22		29		43	38	58		
		Heating	23		30		39	62	58		
	Running current *1	Cooling	0.22		0.29		0.39	0.35	0.51		
		Heating	0.23		0.31		0.36	0.53	0.51		
Fan motor	Model		RC0J40-FK				RC0J56-AF				
	Current *1	Cooling	0.22		0.29		0.39	0.35	0.51		
		Heating	0.23		0.31		0.36	0.53	0.51		
Dimensions W × H × D		mm	798 × 295 × 232				1100 × 325 × 238				
Weight		kg	10				16				
Air direction			5								
Special remarks	Airflow	Cooling	Super High + LONG + POWERFUL		-				1,242	1,164	
			m <sup>3</sup> /h	Super High	678	762	768	906	1,098	1,068	
				High	546 (552 *2)			624	714	936	924
				Med.	402	402 (414 *2)		516	576	804	798
				Low	288 (276 *2)		288	408	468	678	690
				Silent	246		348	390	588	582	
		Heating		Super High + LONG + POWERFUL		-				1,242	1,164
		m <sup>3</sup> /h	Super High	690		786	870	1,098	1,068		
			High	546			624	732	936 (882 *2)	924	
			Med.	396	402	516	576	804	798		
			Low	288 (276 *2)		288	420	468	678	690	
			Silent	246		348	390	588	612		
	Sound level	Cooling	Super High + LONG + POWERFUL		-				52	53	
			dB(A)	Super High	42	43	46	49			
				High	36			40	44	45	
				Med.	29	30	35	38	41		
				Low	21	22	30	33	37		
				Silent	19		26	28	29	30	
		Heating		Super High + LONG + POWERFUL		-				52	
		dB(A)	Super High	42		46	48	49			
			High	36			40	43	45		
			Med.	29	30	35	37	41			
			Low	21	22	30	33	37			
			Silent	19		26	28	29	30		
Fan speed	Cooling	Super High + LONG + POWERFUL		-				1,280	1,300		
		rpm	Super High	1,020	1,120	1,120	1,280	1,090	1,140		
			High	860			950	1,060	960	1,010	
			Med.	670	670 (690 *2)		810	890	850	900	
			Low	530		680	750	740	800		
			Silent	470		600	650 (690 *2)	660	700		
	Heating		Super High + LONG + POWERFUL		-				1,280	1,300	
	rpm	Super High	1,040		1,140	1,240	1,090	1,140			
		High	860 (700 *2)			950 (930 *2)	1,080 (930 *2)	960 (910 *2)	1,010		
		Med.	670 (610 *2)		810	890 (840 *2)	850	900			
		Low	530		690	750	740	800			
		Silent	470		600	650	660	730			
Fan speed regulator		5									
Remote controller model			KM09A				SG10A				

**NOTE:** Test conditions are based on ISO 5151.

Cooling: Indoor Dry-bulb temperature 27°C Wet-bulb temperature 19°C

Outdoor Dry-bulb temperature 35°C

Heating: Indoor Dry-bulb temperature 20°C

Outdoor Dry-bulb temperature 7°C Wet-bulb temperature 6°C

\*1 Measured under rated operating frequency.

\*2 For multi system.

## Specifications and rating conditions of main electric parts

Fuse	(F11)	T3.15AL250V
Horizontal vane motor	(MV), (MV1)	12 VDC
Vertical vane motor MSZ-GE60VA MSZ-GE71VA	(MV2)	12 VDC
Varistor	(NR11)	S10K300E3K1 (ERZV14D471)
Terminal block	(TB)	3P

## 4 NOISE CRITERIA CURVES

### MSZ-GE22VA MSZ-GE25VA

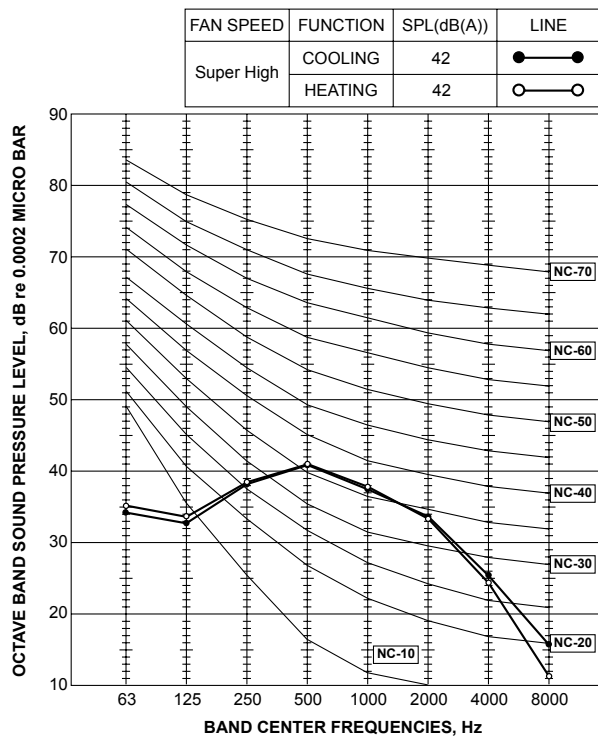

### MSZ-GE35VA

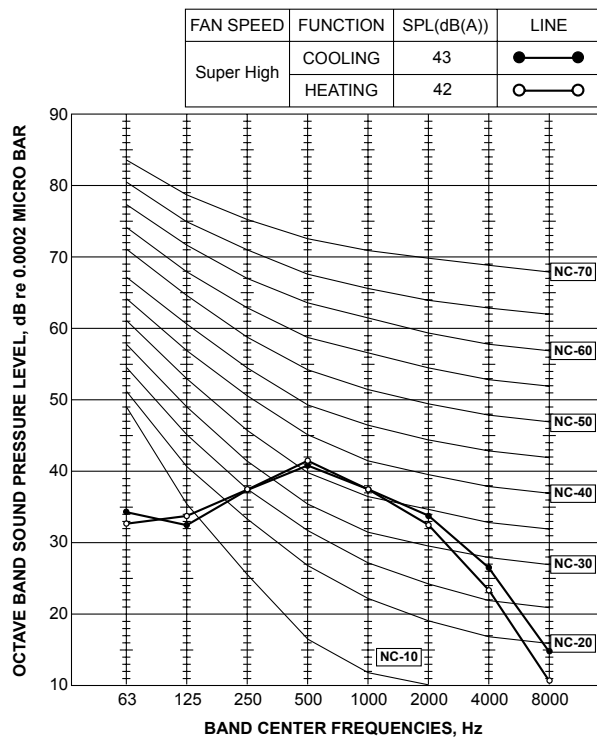

### MSZ-GE42VA

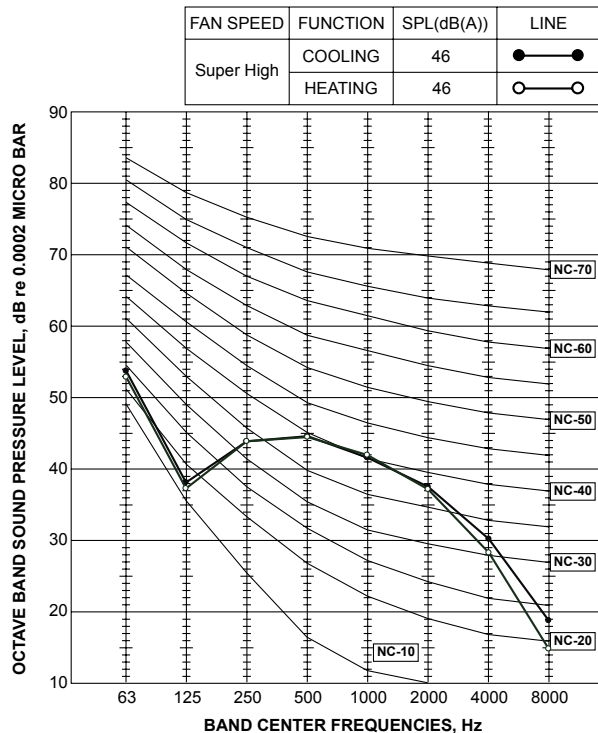

### MSZ-GE50VA

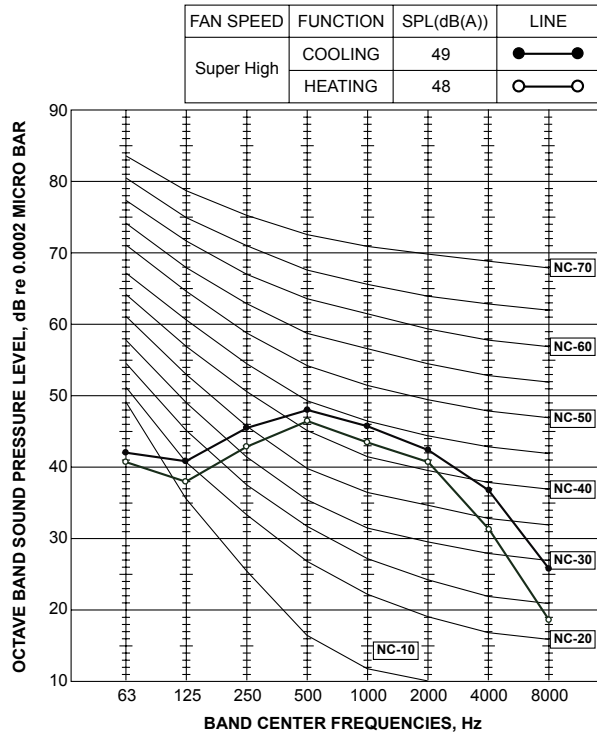

## MSZ-GE60VA

FAN SPEED	FUNCTION	SPL(dB(A))	LINE
Super High	COOLING	49	●—●
	HEATING	49	○—○

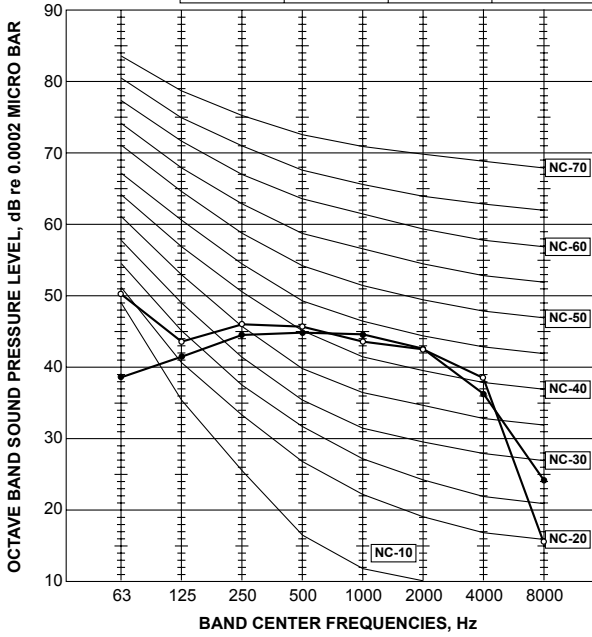

## MSZ-GE71VA

FAN SPEED	FUNCTION	SPL(dB(A))	LINE
Super High	COOLING	49	●—●
	HEATING	49	○—○

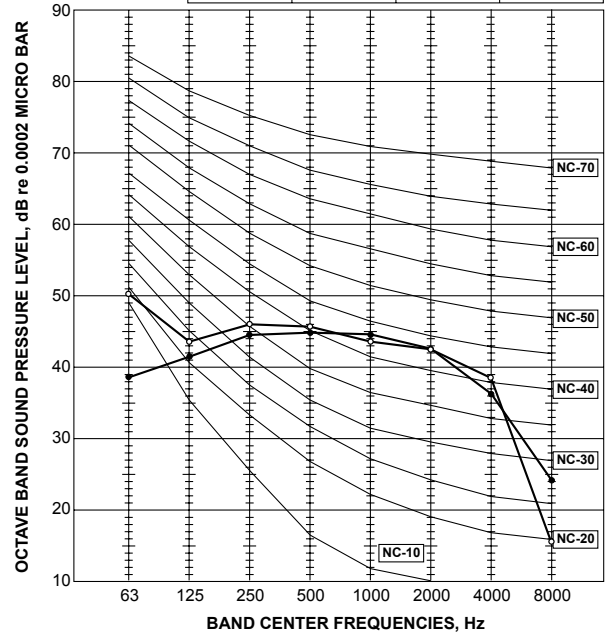

### Test conditions

Cooling: Dry-bulb temperature 27°C  
 Wet-bulb temperature 19°C  
 Heating: Dry-bulb temperature 20°C

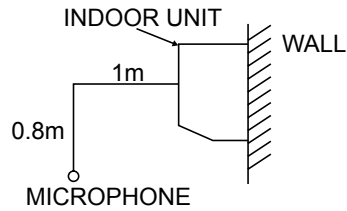

# 5

# OUTLINES AND DIMENSIONS

**MSZ-GE22VA MSZ-GE25VA MSZ-GE35VA MSZ-GE42VA MSZ-GE50VA**

Unit: mm

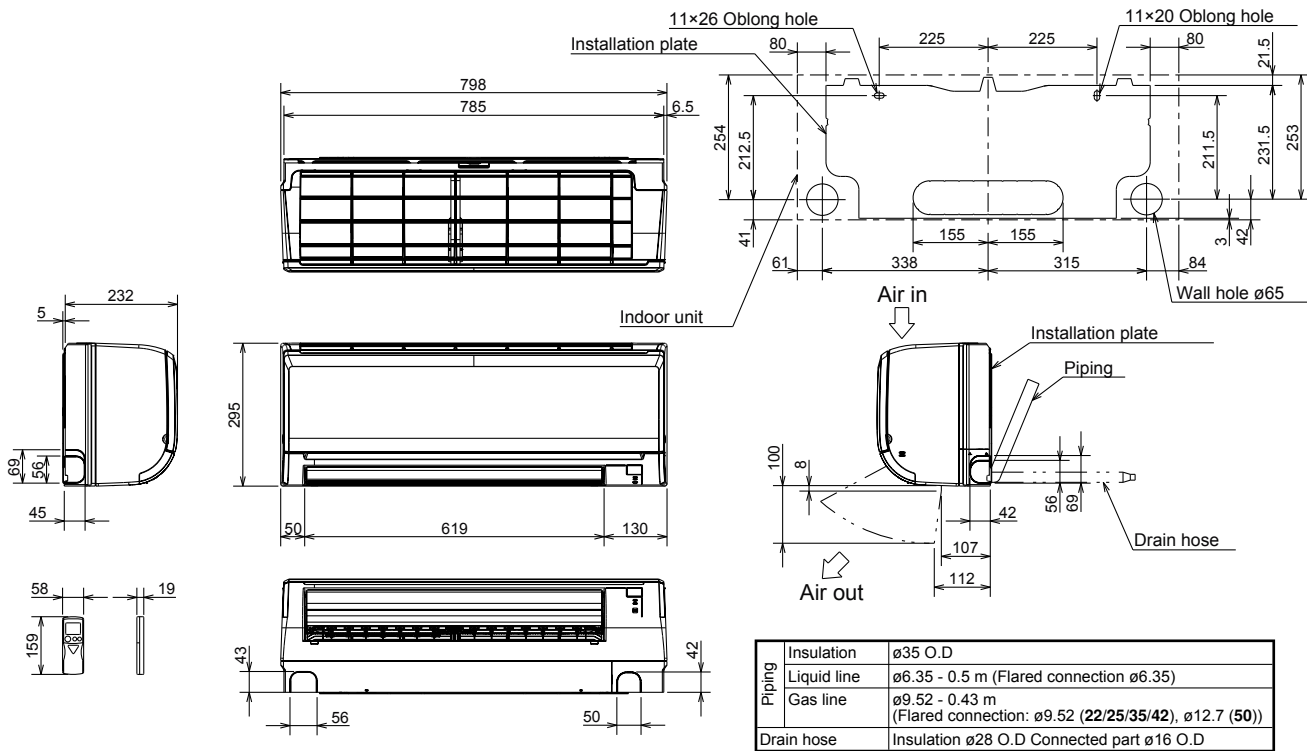

**MSZ-GE60VA MSZ-GE71VA**

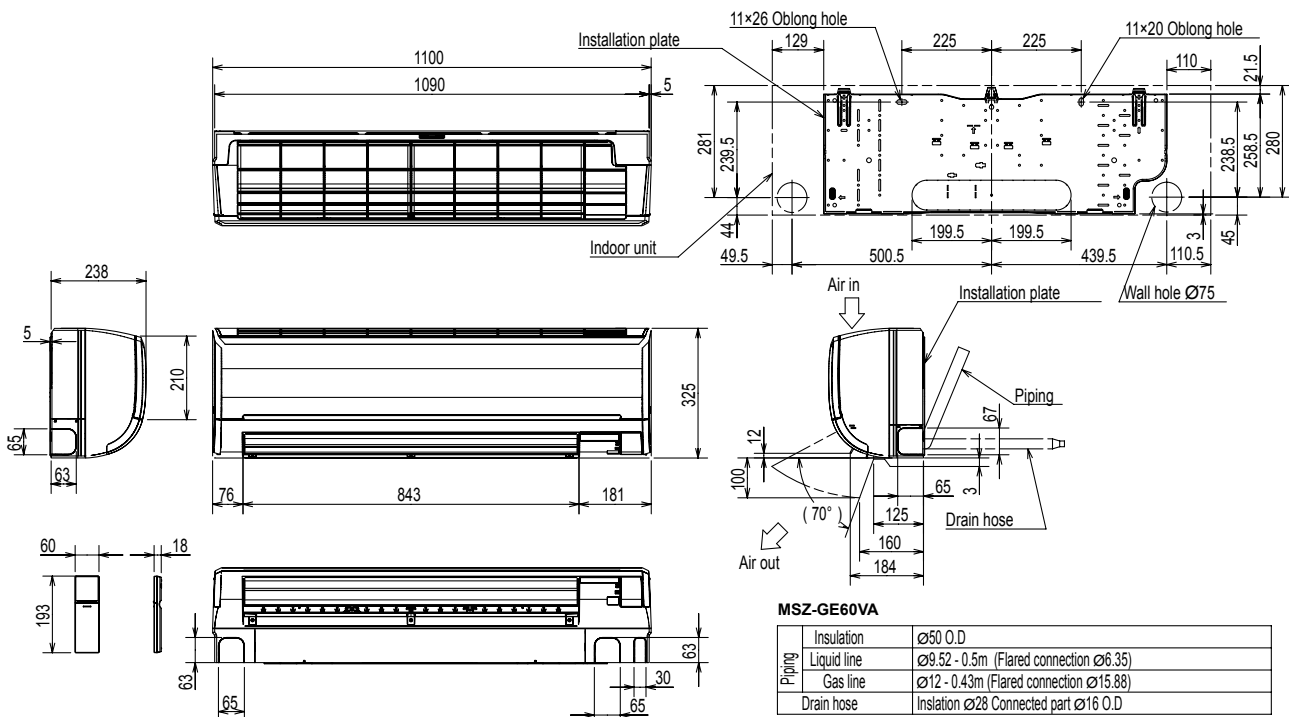

<b>MSZ-GE71VA</b>	
Insulation	ø50 O.D
Liquid line	ø9.52 - 0.5m (Flared connection ø9.52)
Gas line	ø12 - 0.43m (Flared connection ø15.88)
Drain hose	Insulation ø28 Connected part ø16 O.D

# 6

# WIRING DIAGRAM

## MSZ-GE22VA MSZ-GE25VA MSZ-GE35VA

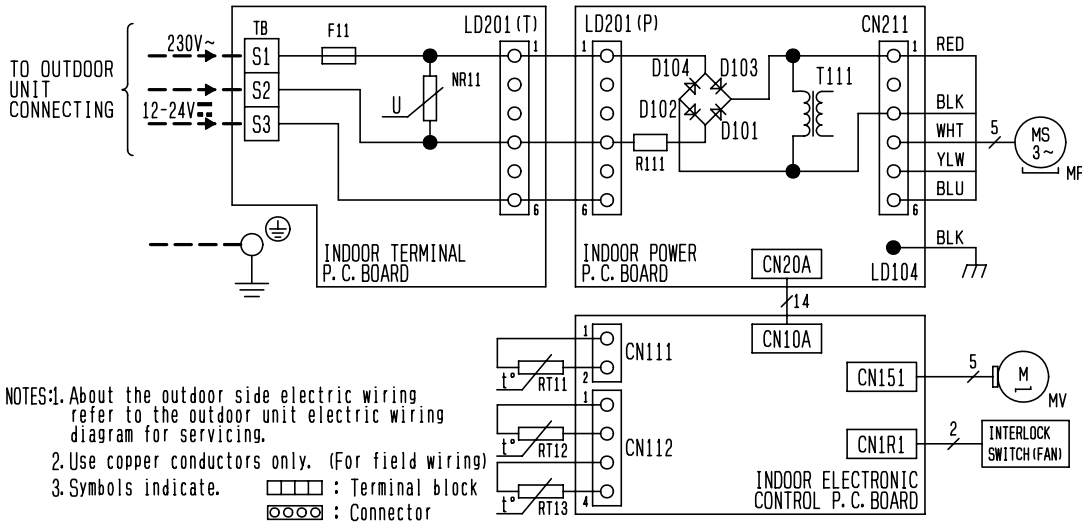

SYMBOL	NAME
D101~D104	DIODE
F11	FUSE (T3. 15AL250V)
MF	FAN MOTOR
MV	VANE MOTOR (HORIZONTAL)
NR11	VARISTOR
R111	RESISTOR (3.9Ω/5W)
RT11	ROOM TEMP. THERMISTOR
RT12	COIL TEMP. THERMISTOR (MAIN)
RT13	COIL TEMP. THERMISTOR (SUB)
T111	TRANSFORMER
TB	TERMINAL BLOCK

## MSZ-GE42VA MSZ-GE50VA

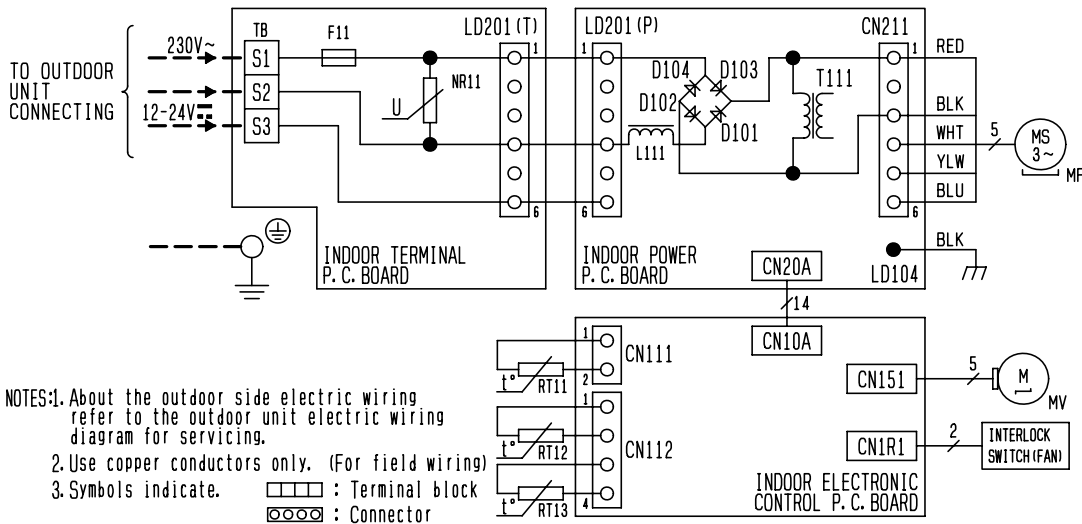

SYMBOL	NAME
D101~D104	DIODE
F11	FUSE (T3. 15AL250V)
L111	REACTOR
MF	FAN MOTOR
MV	VANE MOTOR (HORIZONTAL)
NR11	VARISTOR
RT11	ROOM TEMP. THERMISTOR
RT12	COIL TEMP. THERMISTOR (MAIN)
RT13	COIL TEMP. THERMISTOR (SUB)
T111	TRANSFORMER
TB	TERMINAL BLOCK

## MSZ-GE60VA MSZ-GE71VA

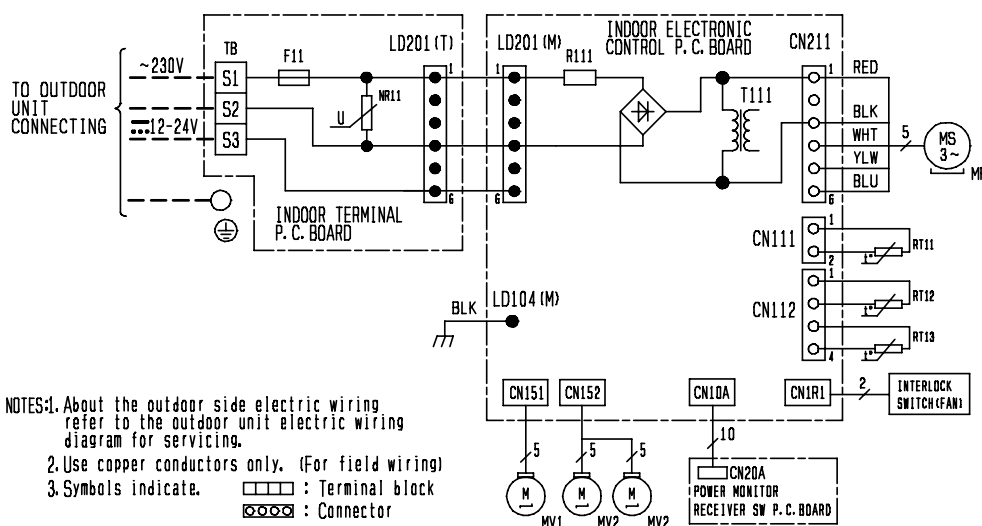

SYMBOL	NAME
F11	FUSE (T3. 15AL250V)
MF	FAN MOTOR
MV1	VANE MOTOR (HORIZONTAL)
MV2	VANE MOTOR (VERTICAL)
NR11	VARISTOR
R111	RESISTOR
RT11	ROOM TEMP. THERMISTOR
RT12	COIL TEMP. THERMISTOR (MAIN)
RT13	COIL TEMP. THERMISTOR (SUB)
T111	TRANSFORMER
TB	TERMINAL BLOCK

MSZ-GE22VA MSZ-GE25VA MSZ-GE35VA MSZ-GE42VA MSZ-GE50VA

Unit: mm

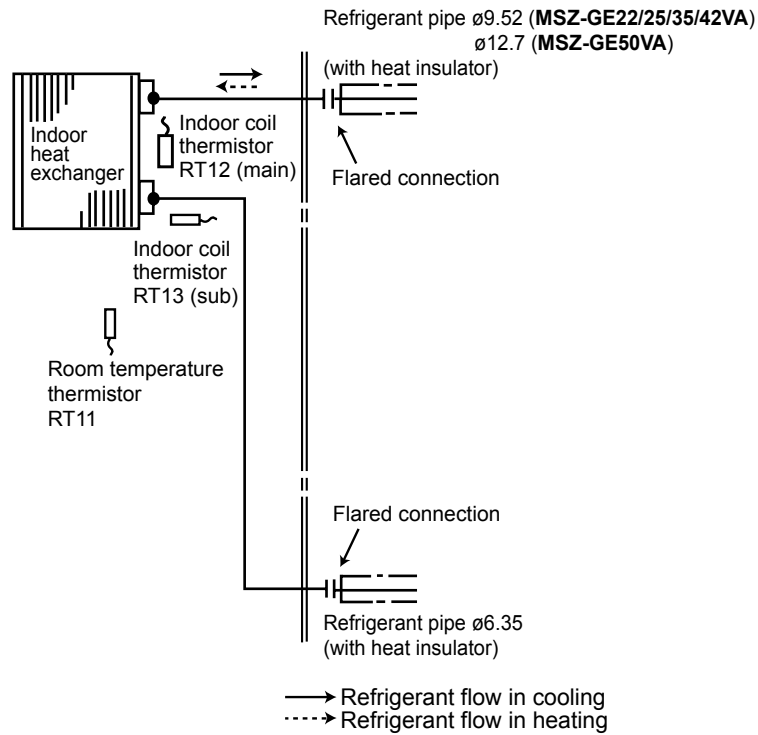

MSZ-GE60VA MSZ-GE71VA

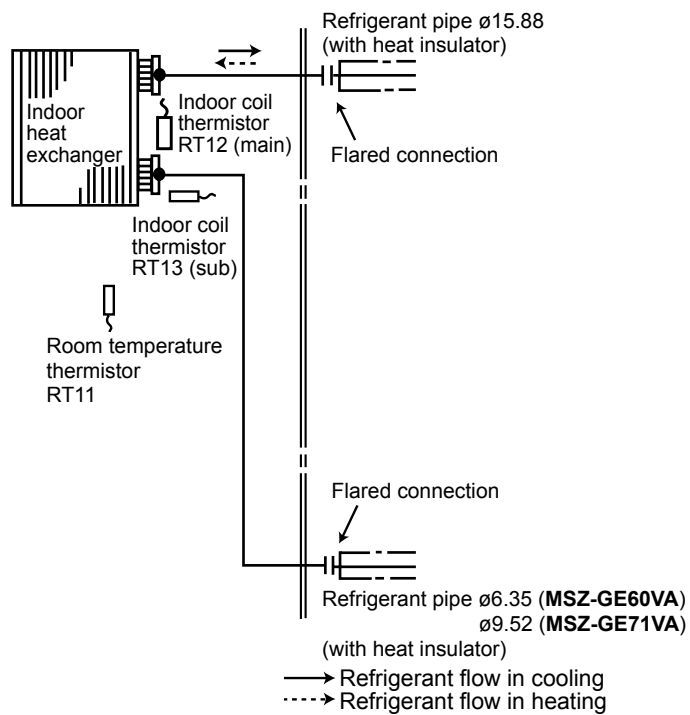

## MSZ-GE22VA MSZ-GE25VA MSZ-GE35VA MSZ-GE42VA MSZ-GE50VA MSZ-GE60VA MSZ-GE71VA

### 8-1. TIMER SHORT MODE

For service, set time can be shortened by short circuit of JPG and JPS on the electronic control P.C. board.  
The time will be shortened as follows. (Refer to 10-7.2.3.)

Set time: 1 minute → 1 second

Set time: 3 minutes → 3 seconds (It takes 3 minutes for the compressor to start operation. However, the starting time is shortened by short circuit-of JPG and JPS.)

### 8-2. P.C. BOARD MODIFICATION FOR INDIVIDUAL OPERATION

A maximum of 4 indoor units with wireless remote controllers can be used in a room.

In this case, to operate each indoor unit individually by each remote controller, P.C. boards of remote controller must be modified according to the number of the indoor unit.

#### How to modify the remote controller P.C. board

Remove batteries before modification.

The board has a print as shown below:

### MSZ-GE22VA MSZ-GE25VA MSZ-GE35VA MSZ-GE42VA MSZ-GE50VA

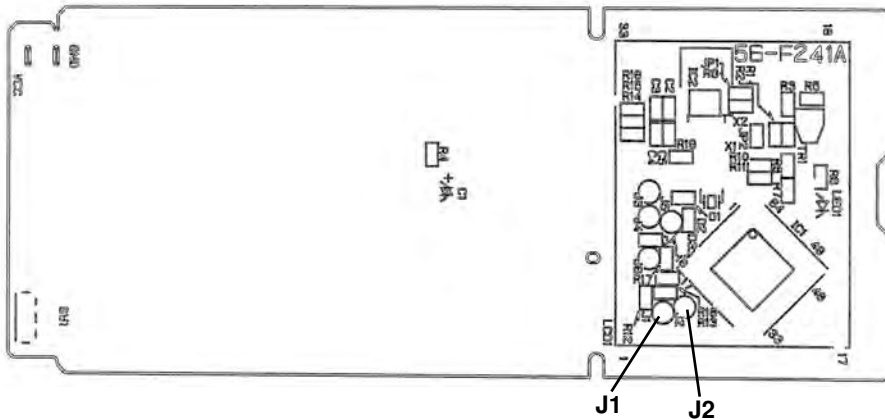

**NOTE:** For modification, take out the batteries and press the OPERATE/STOP (ON/OFF) button twice or 3 times at first. After modification, put back the batteries then press the RESET button.

### MSZ-GE60VA MSZ-GE71VA

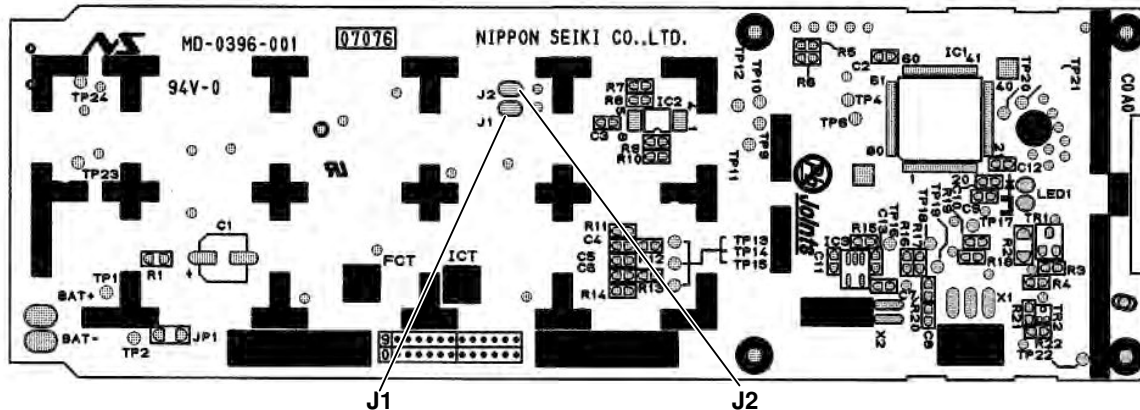

The P.C. board has the print "J1" and "J2". Solder "J1" and "J2" according to the number of indoor unit as shown in Table 1. After modification, press the RESET button.

**Table 1**

	1 unit operation	2 units operation	3 units operation	4 units operation
No. 1 unit	No modification	Same as at left	Same as at left	Same as at left
No. 2 unit	—	Solder J1	Same as at left	Same as at left
No. 3 unit	—	—	Solder J2	Same as at left
No. 4 unit	—	—	—	Solder both J1 and J2

#### How to set the remote controller exclusively for particular indoor unit

After you turn the breaker ON, the first remote controller that sends the signal to the indoor unit will be regarded as the remote controller for the indoor unit.

The indoor unit will only accept the signal from the remote controller that has been assigned to the indoor unit once they are set. The setting will be cancelled if the breaker is turned OFF, or the power supply is shut down.

Please conduct the above setting once again after the power has restored.

### 8-3. AUTO RESTART FUNCTION

When the indoor unit is controlled with the remote controller, the operation mode, the set temperature, and the fan speed are memorized by the indoor electronic control P.C. board. "AUTO RESTART FUNCTION" automatically starts operation in the same mode just before the shutoff of the main power.

#### Operation

- ① If the main power has been cut, the operation settings remain.
- ② After the power is restored, the unit restarts automatically according to the memory.  
(However, it takes at least 3 minutes for the compressor to start running.)

#### How to release "AUTO RESTART FUNCTION"

- ① Turn off the main power for the unit.
- ② Solder the jumper wire to JR07 on the indoor electronic control P.C. board. (Refer to 10-7.2.3.)

**MSZ-GE22VA MSZ-GE25VA MSZ-GE35VA**  
**MSZ-GE42VA MSZ-GE50VA**

**MSZ-GE60VA MSZ-GE71VA**

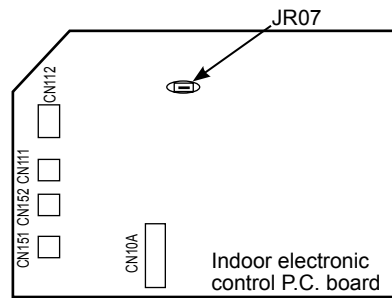
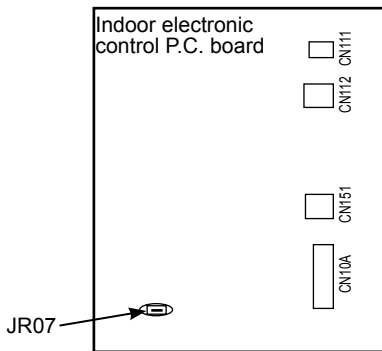

#### NOTE:

- The operation settings are memorized when 10 seconds have passed after the indoor unit was operated with the remote controller.
- If main power is turned OFF or a power failure occurs while AUTO START/STOP timer is active, the timer setting is cancelled.
- If the unit has been off with the remote controller before power failure, the auto restart function does not work as the power button of the remote controller is OFF.
- To prevent breaker OFF due to the rush of starting current, systematize other home appliance not to turn ON at the same time.
- When some air conditioners are connected to the same supply system, if they are operated before power failure, the starting current of all the compressors may flow simultaneously at restart. Therefore, the special counter-measures are required to prevent the main voltage-drop or the rush of the starting current by adding to the system that allows the units to start one by one.

**MSZ-GE22VA MSZ-GE25VA MSZ-GE35VA MSZ-GE42VA MSZ-GE50VA  
MSZ-GE60VA MSZ-GE71VA**

**WIRELESS REMOTE CONTROLLER**

**MSZ-GE22VA MSZ-GE25VA MSZ-GE35VA MSZ-GE42VA MSZ-GE50VA**

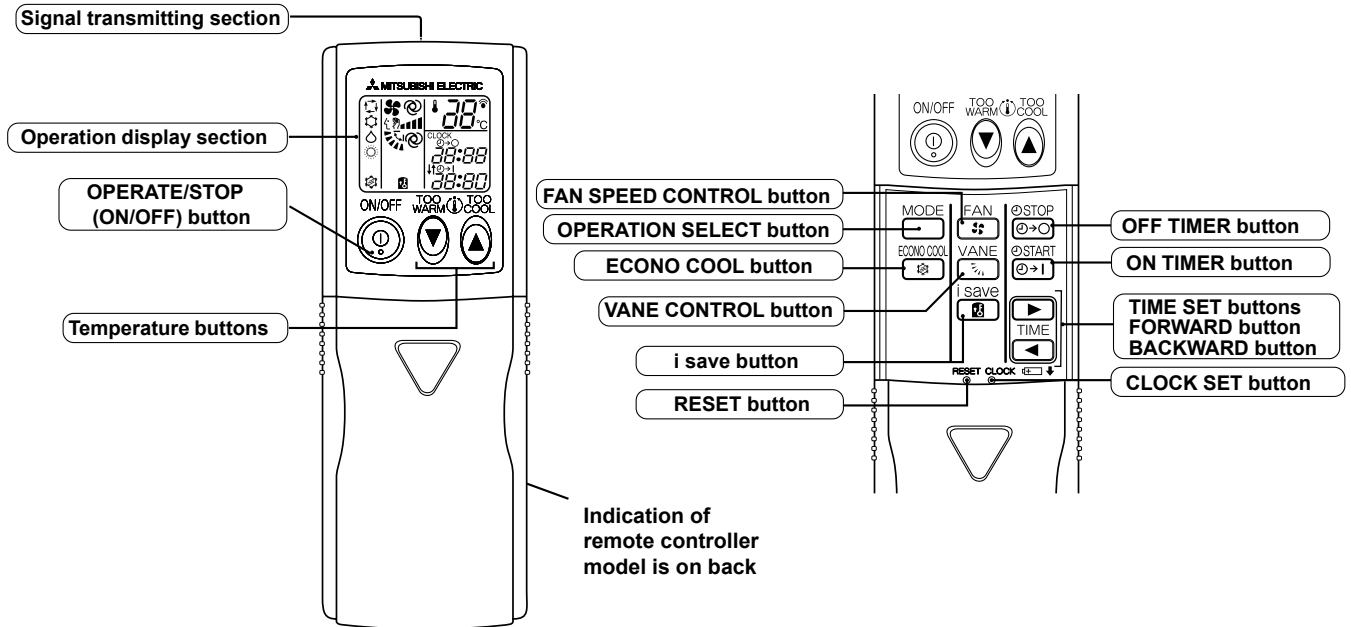

**MSZ-GE60VA MSZ-GE71VA**

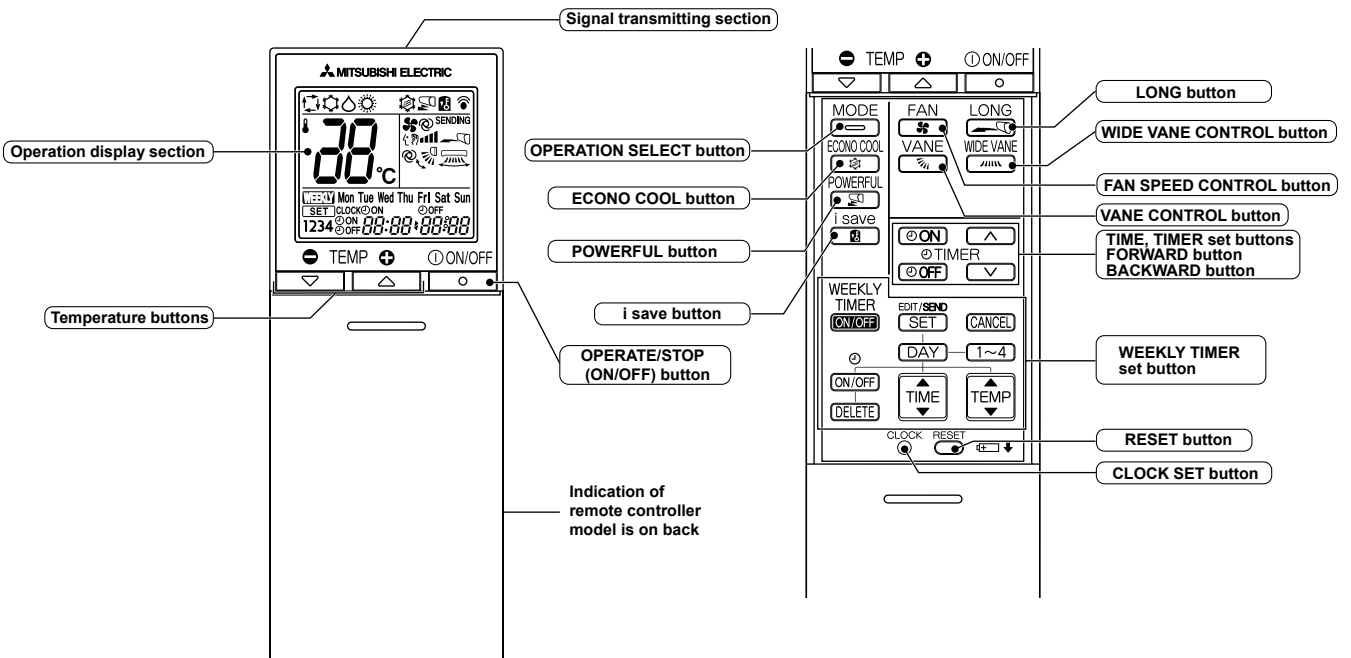







**NOTE:** Last setting will be stored after the unit is turned OFF with the remote controller. Indoor unit receives the signal of the remote controller with beeps.



## INDOOR UNIT DISPLAY SECTION

### Operation Indicator lamp



The operation indicator at the right side of the indoor unit indicates the operation state.

•The following indication applies regardless of shape of the indication.

Indication	Operation state	Room temperature
 	The unit is operating to reach the set temperature	About 2°C or more away from set temperature
 	The room temperature is approaching the set temperature	About 1 to 2°C from set temperature
 	Standby mode (Only during multi system operation)	—

-  Lighted
-  Blinking
-  Not lighted

### 9-1. COOL (❄️) OPERATION

- (1) Press OPERATE/STOP (ON/OFF) button.  
OPERATION INDICATOR lamp of the indoor unit turns on with a beep tone.
- (2) Select COOL mode with OPERATION SELECT button.
- (3) Press TEMPERATURE buttons [TOO WARM or TOO COOL button (**MSZ-22/25/35/42/50VA**)/TEMP  or  button (**MSZ-GE60/71VA**)] to select the desired temperature. The setting range is 16 - 31°C.

#### 1. Coil frost prevention

The compressor operational frequency is controlled by the temperature of the indoor heat exchanger to prevent the coil from frosting.

When the temperature of indoor heat exchanger becomes too low, the coil frost prevention mode works.

The indoor fan operates at the set speed and the compressor stops. This mode continues until the temperature of indoor heat exchanger rises.

#### 2. Low outside temperature operation

When the outside temperature is lower, low outside temperature operation starts, and the outdoor fan slows or stops.

#### 3. Indoor fan speed control

When the thermostat turns OFF, the indoor fan stops running to reduce power consumption.

After that, the indoor fan stops for 60 seconds and then operates at Very Low for 10 seconds to sense accurate room temperature. The indoor fan alternates ON and OFF at this interval while the thermostat is OFF.

When the room temperature rises and the thermostat is ON, the indoor fan starts running according to the settings on the remote controller. (**MSZ-GE60/71VA**)

### 9-2. DRY (☀️) OPERATION

- (1) Press OPERATE/STOP (ON/OFF) button.  
OPERATION INDICATOR lamp of the indoor unit turns on with a beep tone.
- (2) Select DRY mode with OPERATION SELECT button.
- (3) The set temperature is determined from the initial room temperature.

#### 1. Coil frost prevention

Coil frost prevention is as same as COOL mode. (9-1.1.)



#### 2. Low outside temperature operation

Low outside temperature operation is as same as COOL mode. (9-1.2.)

#### 3. Indoor fan speed control

Indoor fan speed control is as same as COOL mode. (9-1.3.)

### 9-3. HEAT (🔥) OPERATION

- (1) Press OPERATE/STOP (ON/OFF) button.  
OPERATION INDICATOR lamp of the indoor unit turns on with a beep tone.
- (2) Select HEAT mode with OPERATION SELECT button.
- (3) Press TEMPERATURE buttons [TOO WARM or TOO COOL button (**MSZ-22/25/35/42/50VA**)/TEMP  or  button (**MSZ-GE60/71VA**)] to select the desired temperature. The setting range is 16 - 31°C.

#### 1. Cold air prevention control

When the compressor is not operating or is starting, and the temperature of indoor heat exchanger and/or the room temperature is low or when defrosting is being done, the indoor fan will stop or rotate in Very Low speed.

#### 2. High pressure protection

The compressor operational frequency is controlled by the temperature of the indoor heat exchanger to prevent the condensing pressure from increasing excessively.

When the temperature of indoor heat exchanger becomes too high, the high pressure protection works.

The indoor fan operates following the cold air prevention control. This mode continues until the temperature of indoor heat exchanger falls.

#### 3. Defrosting

Defrosting starts when the temperature of outdoor heat exchanger becomes too low.

The compressor stops once, the indoor/outdoor fans stop, the 4-way valve reverses, and the compressor re-starts.

This mode continues until the temperature of outdoor heat exchanger rises or the fixed time passes.

## 9-4. AUTO CHANGE OVER ... AUTO MODE OPERATION

Once desired temperature is set, unit operation is switched automatically between COOL and HEAT operation.

### Mode selection

#### (1) Initial mode

When unit starts the operation with AUTO operation from OFF:

- If the room temperature is higher than the set temperature, operation starts in COOL mode.
- If the room temperature is equal to or lower than the set temperature, operation starts in HEAT mode.

#### (2) Mode change

COOL mode changes to HEAT mode when about 15 minutes have passed with the room temperature 1°C below the set temperature.

HEAT mode changes to COOL mode when about 15 minutes have passed with the room temperature 1°C above the set temperature.

### NOTE 1

If two or more indoor units are operating in multi system, there might be a case that the indoor unit, which is operating in □ (AUTO), cannot change over to the other operating mode (COOL ↔ HEAT) and becomes a state of standby.

Refer to **NOTE 2 "FOR MULTI SYSTEM AIR CONDITIONER"**.

### NOTE 2

#### FOR MULTI SYSTEM AIR CONDITIONER

##### OUTDOOR UNIT: MXZ series

Multi system air conditioner can connect two or more indoor units with one outdoor unit.

- When you try to operate two or more indoor units with one outdoor unit simultaneously, one for the cooling and the others for heating, the operation mode of the indoor unit that operates first is selected. Other indoor units cannot operate, and operation indicator lamp flashes as shown in the figure below. In this case, please set all the indoor units to the same operation mode.

#### OPERATION INDICATOR

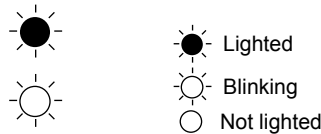

- When indoor unit starts the operation while the defrosting of outdoor unit is being done, it takes a few minutes (max. 10 minutes) to blow out the warm air.
- In the heating operation, though indoor unit that does not operate may get warm or the sound of refrigerant flowing may be heard, they are not malfunction. The reason is that the refrigerant continuously flows into it.

## 9-5. AUTO VANE OPERATION

### 1. Horizontal vane

#### (1) Vane motor drive

These models are equipped with a stepping motor for the horizontal vane. The rotating direction, speed, and angle of the motor are controlled by pulse signals (approximate 12 V) transmitted from indoor microprocessor.

#### (2) The horizontal vane angle and mode change as follows by pressing VANE CONTROL button.

**MSZ-GE22VA MSZ-GE25VA MSZ-GE35VA MSZ-GE42VA MSZ-GE50VA**

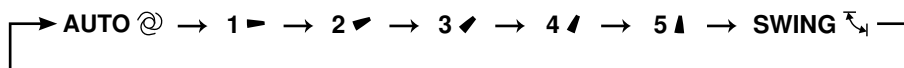

**MSZ-GE60VA MSZ-GE71VA**

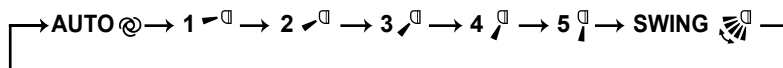

#### (3) Positioning

To confirm the standard position, the vane moves until it touches the vane stopper. Then the vane is set to the selected angle.

Confirming of standard position is performed in the following cases:

- When the operation starts or finishes (including timer operation).
- When the test run starts.
- When standby mode (only during multi system operation) starts or finishes.

#### (4) VANE AUTO (@) mode

In VANE AUTO mode, the microprocessor automatically determines the vane angle to make the optimum room temperature distribution.

In COOL and DRY operation

Vane angle is fixed to Horizontal position.



Horizontal position

In HEAT operation

Vane angle is fixed to Angle 5.

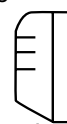

5

(5) STOP (operation OFF) and ON TIMER standby

In the following cases, the horizontal vane returns to the closed position.

- (a) When OPERATE/STOP (ON/OFF) button is pressed (POWER OFF).
- (b) When the operation is stopped by the emergency operation.
- (c) When ON TIMER is ON standby.

(6) Dew prevention

During COOL or DRY operation with the vane angle at Angle 4 or 5 when the compressor cumulative operation time exceeds 1 hour, the vane angle automatically changes to Angle 1 for dew prevention.

(7) SWING (↕ or ↕) mode

By selecting SWING mode with VANE CONTROL button, the horizontal vane swings vertically.

(8) Cold air prevention in HEAT operation

The horizontal vane position is set to Upward.

**NOTE:** When 2 or more indoor units are operated with multi outdoor unit, even if any indoor unit turns thermostat off, this control does not work in the indoor unit.

(9) ECONO COOL (🌀) operation (ECONomical operation)

When ECONO COOL button is pressed in COOL mode, set temperature is automatically set 2°C higher.

Also the horizontal vane swings in various cycle.

SWING operation makes you feel cooler than set temperature. So, even though the set temperature is higher, the air conditioner can keep comfort. As a result, energy can be saved.

To cancel this operation, select a different mode or press one of the following buttons in ECONO COOL operation: ECONO COOL, VANE CONTROL, LONG (MSZ-GE60/71VA) or POWERFUL (MSZ-GE60/71VA) button.

(10) POWERFUL (🌀) operation (MSZ-GE60VA MSZ-GE71VA)

The air conditioner automatically adjusts the fan speed and the set temperature, and operates the POWERFUL mode.

The POWERFUL mode is cancelled automatically 15 minutes after operation starts, or when POWERFUL button is pressed once again within 15 minutes after operation starts. The operation mode returns to the mode prior to POWERFUL operation. POWERFUL mode also is cancelled, when the OPERATE/STOP (ON/OFF) ECONO COOL, FAN SPEED CONTROL or i-save button is pressed within 15 minutes after operation starts, or operation mode is changed.

(11) LONG MODE (🌀) (MSZ-GE60VA MSZ-GE71VA)

By pressing LONG button indoor fan speed becomes faster than setting fan speed on the remote controller, and the horizontal vane moves to the position for LONG mode. The remote controller displays "🌀". LONG mode is cancelled when LONG button is pressed once again or VANE CONTROL button is pressed or ECONO COOL button is pressed in COOL mode. In the following example, the vertical vane is set to 🌀 (front.).

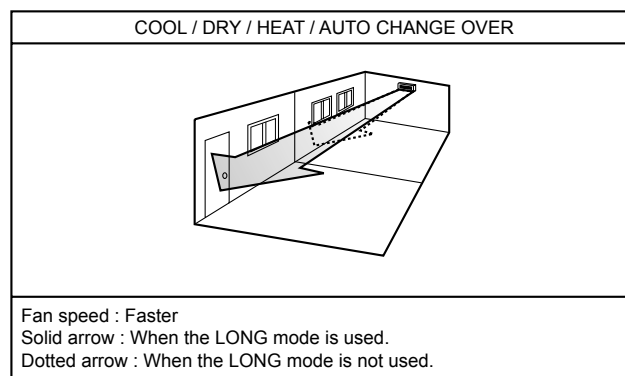

2. Vertical vane (MSZ-GE60VA MSZ-GE71VA )

(1) Vane motor drive

These models are equipped with a stepping motor for the vertical vane. The rotating direction, speed, and angle of the motor are controlled by pulse signals (approximate 12 V) transmitted from microprocessor.

(2) The vertical vane angle and mode change as follows by pressing WIDE VANE CONTROL button.

(3) Positioning

To confirm the standard position, the vane moves until it touches the vane stopper. Then the vane is set to the selected angle.

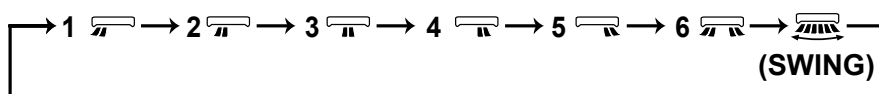

Confirming of standard position is performed in the following cases:

- (a) OPERATE/STOP (ON/OFF) button is pressed (POWER ON).
- (b) SWING is started.

(4) SWING (  ) MODE

By selecting SWING mode with WIDE VANE CONTROL button, the vertical vane swings horizontally. The remote controller displays "  ". Swing mode is cancelled when WIDE MODE CONTROL button is pressed once again.









## 9-6. TIMER OPERATION

### 1. How to set the time







- (1) Check that the current time is set correctly.

**NOTE:** Timer operation will not work without setting the current time. Initially "0:00" blinks at the current time display of TIME MONITOR, so set the current time correctly with CLOCK SET button.











#### How to set the current time

- (a) Press the CLOCK set button.  
 (b) Press the TIME SET buttons (  and  /  and  ) to set the current time.  
 • Each time FORWARD button (  /  ) is pressed, the set time increases by 1 minute, and each time BACKWARD button (  /  ) is pressed, the set time decreases by 1 minute.  
 • Pressing those buttons longer, the set time increases/decreases by 10 minutes.  
 (c) Press the CLOCK set button.  
 (2) Press OPERATE/STOP (ON/OFF) button to start the air conditioner.  
 (3) Set the time of timer.

#### ON timer setting



- (a) Press ON TIMER button (  /  ) during operation.  
 (b) Set the time of the timer using TIME SET buttons (  and  /  and  ).\*

#### OFF timer setting

- (a) Press OFF TIMER button (  /  ) during operation.  
 (b) Set the time of the timer using TIME SET buttons (  and  /  and  ).\*  
 \* Each time FORWARD button (  /  ) is pressed, the set time increases by 10 minutes: each time BACKWARD button (  /  ) is pressed, the set time decreases by 10 minutes.

### 2. To release the timer

To release ON timer, press ON TIMER button (  /  ).

To release OFF timer, press OFF TIMER button (  /  ).

TIMER is cancelled and the display of set time disappears.

## PROGRAM TIMER

- OFF timer and ON timer can be used in combination. The timer of the set time that is reached first will operate first.
- " ↓ / ← " and " ↑ / → " display shows the order of OFF timer and ON timer operation.

(Example 1) The current time is 8:00 PM.

The unit turns off at 11:00 PM, and on at 6:00 AM.

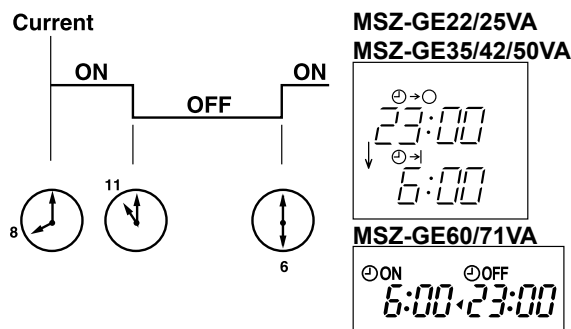

(Example 2) The current time is 11:00 AM.

The unit turns on at 5:00 PM, and off at 9:00 PM.

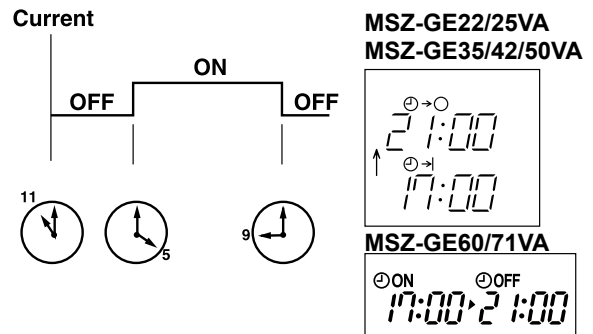

**NOTE:** If the main power is turned OFF or a power failure occurs while ON/OFF timer is active, the timer setting is cancelled. As these models are equipped with an auto restart function, the air conditioner starts operating with timer cancelled when power is restored.

## 9-7. WEEKLY TIMER OPERATION (MSZ-GE60VA MSZ-GE71VA)

- A maximum of 4 ON or OFF timers can be set for individual days of the week.
- A maximum of 28 ON or OFF timers can be set for a week.

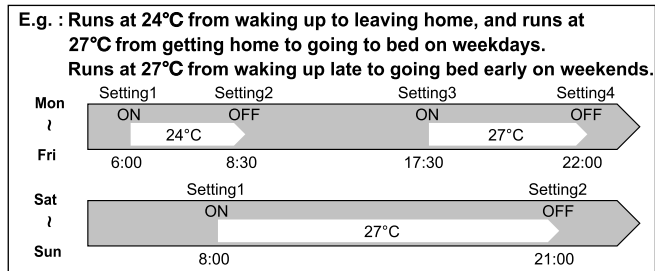

**NOTE:**  
The simple ON/OFF timer setting is available while the weekly timer is on. In this case, the ON/OFF timer has priority over the weekly timer; the weekly timer operation will start again after the simple ON/OFF timer is complete.

### 1. How to set the weekly timer

\* Make sure that the current time and day are set correctly.

(1) Press **EDIT/SEND SET** button to enter the weekly timer setting mode.

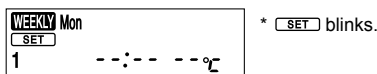

(2) Press **DAY** and **1~4** buttons to select setting day and number.

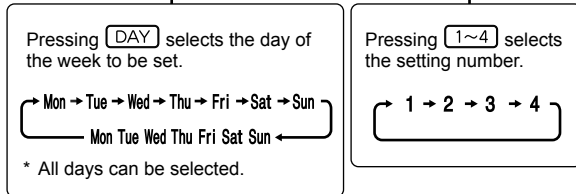
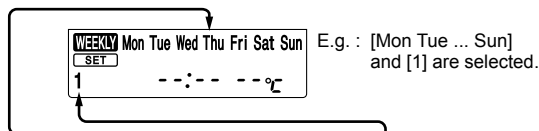

(3) Press **ON/OFF**, **TIME**, and **TEMP** buttons to set ON/OFF, time, and temperature.

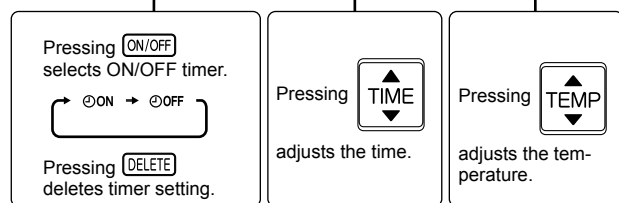

\* Hold down the button to change the time quickly.



Press **DAY** and **1~4** buttons to continue setting the timer for other days and/or numbers.

(4) Press **EDIT/SEND SET** button to complete and transmit the weekly timer setting.





### NOTE:

- Press **EDIT/SEND SET** button to transmit the setting information of weekly timer to the indoor unit. Point the remote controller toward the indoor unit for 3 seconds.
- When setting the timer for more than one day of the week or one number, **EDIT/SEND SET** button does not have to be pressed per each setting. Press **EDIT/SEND SET** button once after all the settings are complete. All the weekly timer settings will be saved.
- Press **EDIT/SEND SET** button to enter the weekly timer setting mode, and press and hold **DELETE** button for 5 seconds to erase all weekly timer settings. Point the remote controller toward the indoor unit.

(5) Press  button to turn the weekly timer ON. (  lights.)

•When the weekly timer is ON, the day of the week whose timer setting is complete, will light.

Press  button again to turn the weekly timer OFF. (  goes out.)



**NOTE:**

The saved settings will not be cleared when the weekly timer is turned OFF.

**2. Checking weekly timer setting**

(1) Press  button to enter the weekly timer setting mode.

\* blinks.

(2) Press  or  buttons to view the setting of the particular day or number.

(3) Press  button to exit the weekly timer setting.

**NOTE:**

When all days of the week are selected to view the settings and a different setting is included among them,  will be displayed.

**9-8. i-save (i) OPERATION**

**1. How to set i-save operation**

- (1) Press OPERATE/STOP (ON/OFF) button.
- (2) Select COOL, HEAT or ECONO COOL mode.
- (3) Press i-save button.
- (4) Set the temperature, fan speed, and airflow direction for i-save operation.

**NOTE:**

- i-save operation cannot be selected during DRY or AUTO mode operation.
- The setting range of HEAT mode i-save operation is 10°C and 16 - 31°C.
- 2 groups of setting can be saved. (One for COOL/ECONO COOL, one for HEAT)

**2. How to cancel operation**

- Press i-save button again.
- i-save operation can also be cancelled by pressing OPERATION SELECT button to change the operation mode. The same setting is select from the next time by simply pressing i-save button.

**9-9. EMERGENCY/TEST OPERATION**

In case of test run operation or emergency operation, use EMERGENCY OPERATION switch on the right side of the indoor unit. Emergency operation is available when the remote controller is missing, has failed or the batteries of the remote controller run down. The unit will start and OPERATION INDICATOR lamp will light. The first 30 minutes of operation is the test run operation. This operation is for servicing. The indoor fan runs at High speed and the system is in continuous operation (The thermostat does not work). After 30 minutes of test run operation, the system shifts to EMERGENCY COOL/HEAT MODE with a set temperature of 24°C. The fan speed shifts to Med. In the test run or emergency operation, the horizontal vane operates in VANE AUTO (@) mode. Emergency operation continues until EMERGENCY OPERATION switch is pressed once or twice or the unit receives any signal from the remote controller. In case of latter, normal operation will start.

Operation mode	COOL/HEAT
Set temperature	24°C
Fan speed	Med.
Horizontal vane	Auto

The operation mode is indicated by the Operation Indicator lamp as following

**Operation Indicator lamp**

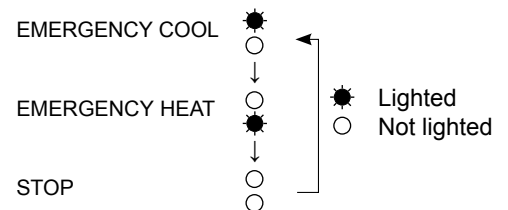

**NOTE:** Do not press EMERGENCY OPERATION switch during normal operation.

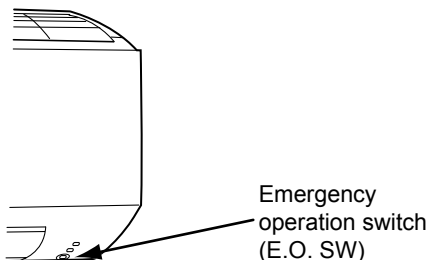

**9-10. 3-MINUTE TIME DELAY OPERATION**

When the system turns OFF, compressor will not restart for 3 minutes as 3-minute time delay function operates to protect compressor from overload.

**MSZ-GE22VA MSZ-GE25VA MSZ-GE35VA MSZ-GE42VA MSZ-GE50VA  
MSZ-GE60VA MSZ-GE71VA**

**10-1. CAUTIONS ON TROUBLESHOOTING**

**1. Before troubleshooting, check the following**

- 1) Check the power supply voltage.
- 2) Check the indoor/outdoor connecting wire for miswiring.

**2. Take care of the following during servicing**

- 1) Before servicing the air conditioner, be sure to turn OFF the main unit first with the remote controller, and then after confirming the horizontal vane is closed, turn OFF the breaker and/or disconnect the power plug.
- 2) Be sure to turn OFF the power supply before removing the front panel, the cabinet, the top panel, and the P.C. board.
- 3) When removing the P.C. board, hold the edge of the board with care NOT to apply stress on the components.
- 4) When connecting or disconnecting the connectors, hold the housing of the connector. DO NOT pull the lead wires.

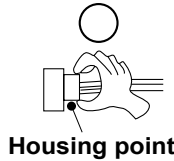

**3. Troubleshooting procedure**

- 1) First, check if the OPERATION INDICATOR lamp on the indoor unit is flashing ON and OFF to indicate an abnormality.  
To make sure, check how many times the abnormality indication is flashing ON and OFF before starting service work.
- 2) Before servicing, check that the connector and terminal are connected properly.
- 3) If the P.C. board is supposed to be defective, check the copper foil pattern for disconnection and the components for bursting and discoloration.
- 4) When troubleshooting, Refer to 10-2, 10-3 and 10-4.

**4. How to replace batteries**

Weak batteries may cause the remote controller malfunction.  
In this case, replace the batteries to operate the remote controller normally.

- ① Remove the front lid and insert batteries.  
Then reattach the front lid.
- ② Press RESET button with a thin instrument, and then use the remote controller.

**MSZ-GE22VA MSZ-GE25VA MSZ-GE35VA MSZ-GE42VA MSZ-GE50VA**

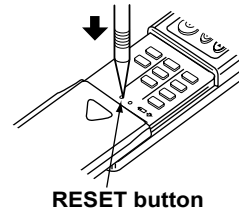
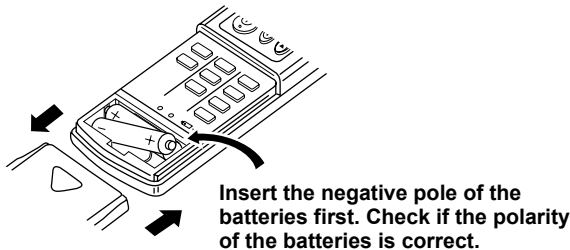

**MSZ-GE60VA MSZ-GE71VA**

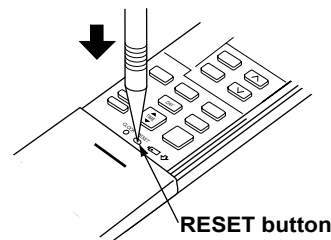
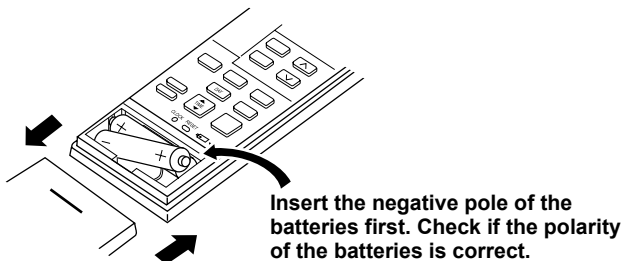

- NOTE:**
- 1. If RESET button is not pressed, the remote controller may not operate correctly.
  - 2. This remote controller has a circuit to automatically reset the microcomputer when batteries are replaced.  
This function is equipped to prevent the microcomputer from malfunctioning due to the voltage drop caused by the battery replacement.
  - 3. Do not use the leaking batteries.

### 5. How to install the horizontal vane

If horizontal vane is not installed correctly, all of the operation indicator lamps will blink.  
In this case, install the horizontal vane correctly by following the procedures ① to ②.

**NOTE:** Before installation of the horizontal vane, turn OFF the power supply.

**MSZ-GE22VA MSZ-GE25VA MSZ-GE35VA MSZ-GE42VA MSZ-GE50VA**

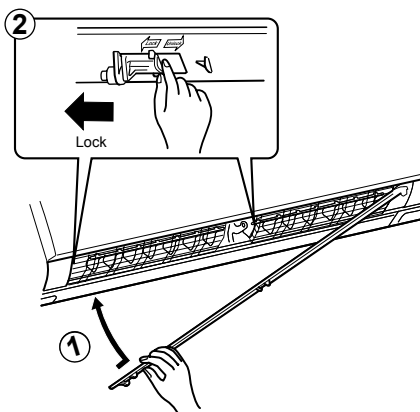

In procedure ② lock the stoppers until they click into place.

**MSZ-GE60VA MSZ-GE71VA**

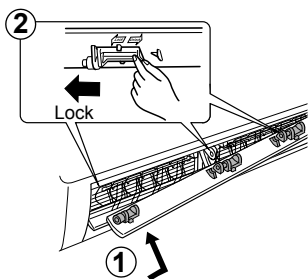

※ Check the upper and the lower vane.

## 10-2. FAILURE MODE RECALL FUNCTION

### Outline of the function

This air conditioner can memorize the abnormal condition which has occurred once.

Even though LED indication listed on the troubleshooting check table (10-4.) disappears, the memorized failure details can be recalled.

### 1. Flow chart of failure mode recall function for the indoor/outdoor unit

MSZ-GE22VA MSZ-GE25VA  
MSZ-GE35VA MSZ-GE42VA  
MSZ-GE50VA

MSZ-GE60VA  
MSZ-GE71VA

#### Operational procedure

The cause of abnormality cannot be found because the abnormality does not recur.

#### Setting up the failure mode recall function

Turn ON the power supply.

<Preparation of the remote controller>

① While pressing both OPERATION SELECT button and TOO COOL button (MSZ-GE22/25/35/42/50VA)/TEMP  $\oplus$  button (MSZ-GE60/71VA) on the remote controller at the same time, press RESET button.

② First, release RESET button.

And release the other two buttons after all LCD in operation display section of the remote controller is displayed after 3 seconds.

Press OPERATE/STOP (ON/OFF) button of the remote controller (the set temperature is displayed) with the remote controller headed towards the indoor unit. ※1

※1 Regardless of normal or abnormal condition, a short beep is emitted once the signal is received.

Does upper lamp of OPERATION INDICATOR lamp on the indoor unit blink at the interval of 0.5 seconds?  
Blinks: Either indoor or outdoor unit is abnormal.  
Beep is emitted at the same timing as the blinking of upper lamp of OPERATION INDICATOR lamp. ※2

No (OFF)

Indoor unit is normal.  
But the outdoor unit might be abnormal because there are some abnormalities that can not be recalled with this way.  
Confirm if outdoor unit is abnormal according to the detailed outdoor unit failure mode recall function.

#### Judgment of indoor/outdoor abnormality

Before blinking, does upper lamp of OPERATION INDICATOR lamp stay ON for 3 seconds?  
Stays ON for 3 seconds (without beep): The outdoor unit is abnormal.

Yes

The indoor unit is abnormal.  
Check the blinking pattern, and confirm the abnormal point with the indoor unit failure mode table. (Refer to 10-2.2)  
Make sure to check at least two consecutive blinking cycles. ※2

No

The outdoor unit is abnormal.  
Check the blinking pattern, and confirm the abnormal point with the outdoor unit failure mode table. (Refer to outdoor unit service manual.)  
Make sure to check at least two consecutive blinking cycles. ※3

#### Releasing the failure mode recall function

Release the failure mode recall function by the following procedures.  
Turn OFF the power supply and turn it ON again.  
Press RESET button of the remote controller.

Repair the defective parts.

#### Deleting the memorized abnormal condition

- ① After repairing the unit, recall the failure mode again according to "Setting up the failure mode recall function" mentioned above.
- ② Press OPERATE/STOP (ON/OFF) button of the remote controller (the set temperature is displayed) with the remote controller headed towards the indoor unit.
- ③ Press EMERGENCY OPERATION switch so that the memorized abnormal condition is deleted.
- ④ Release the failure mode recall function according to "Releasing the failure mode recall function" mentioned above.

**NOTE:** 1. Make sure to release the failure mode recall function once it is set up, otherwise the unit cannot operate properly.  
2. If the abnormal condition is not deleted from the memory, the last abnormal condition is kept memorized.

※2. Blinking pattern when the indoor unit is abnormal:

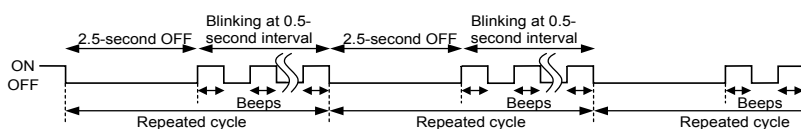

※3. Blinking pattern when the outdoor unit is abnormal:

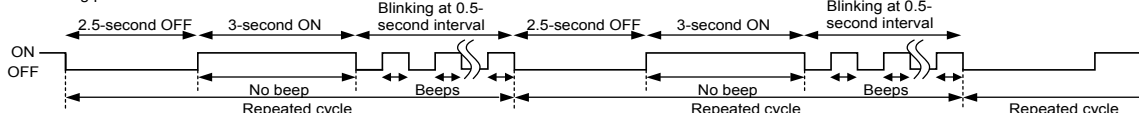



**2. Indoor unit failure mode table**

Upper lamp of OPERATION INDICATOR lamp	Abnormal point (Failure mode)	Condition	Correspondence
Not lighted	Normal	—	—
1-time flash every 0.5-second	Room temperature thermistor	The room temperature thermistor short or open circuit is detected every 8 seconds during operation.	Refer to the characteristics of the room temperature thermistor (10-7.2.3.).
2-time flash 2.5-second OFF	Indoor coil thermistor	The indoor coil thermistor short or open circuit is detected every 8 seconds during operation.	Refer to the characteristics of the main indoor coil thermistor, the sub indoor coil thermistor (10-7.2.3.).
3-time flash 2.5-second OFF	Serial signal	The serial signal from outdoor unit is not received for a maximum of 6 minutes.	Refer to 10-6.Ⓒ "How to check miswiring and serial signal error".
11-time flash 2.5-second OFF	Indoor fan motor	The rotational frequency feedback signal is not emitted during the 12 seconds the indoor fan operation.	Refer to 10-6.Ⓐ "Check of indoor fan motor".
12-time flash 2.5-second OFF	Indoor control system	It cannot properly read data in the nonvolatile memory of the indoor electronic control P.C. board.	Replace the indoor electronic control P.C. board.

**NOTE:** Blinking patterns of this mode differ from the ones of TROUBLESHOOTING CHECK TABLE (10-4.).

### 10-3. INSTRUCTION OF TROUBLESHOOTING

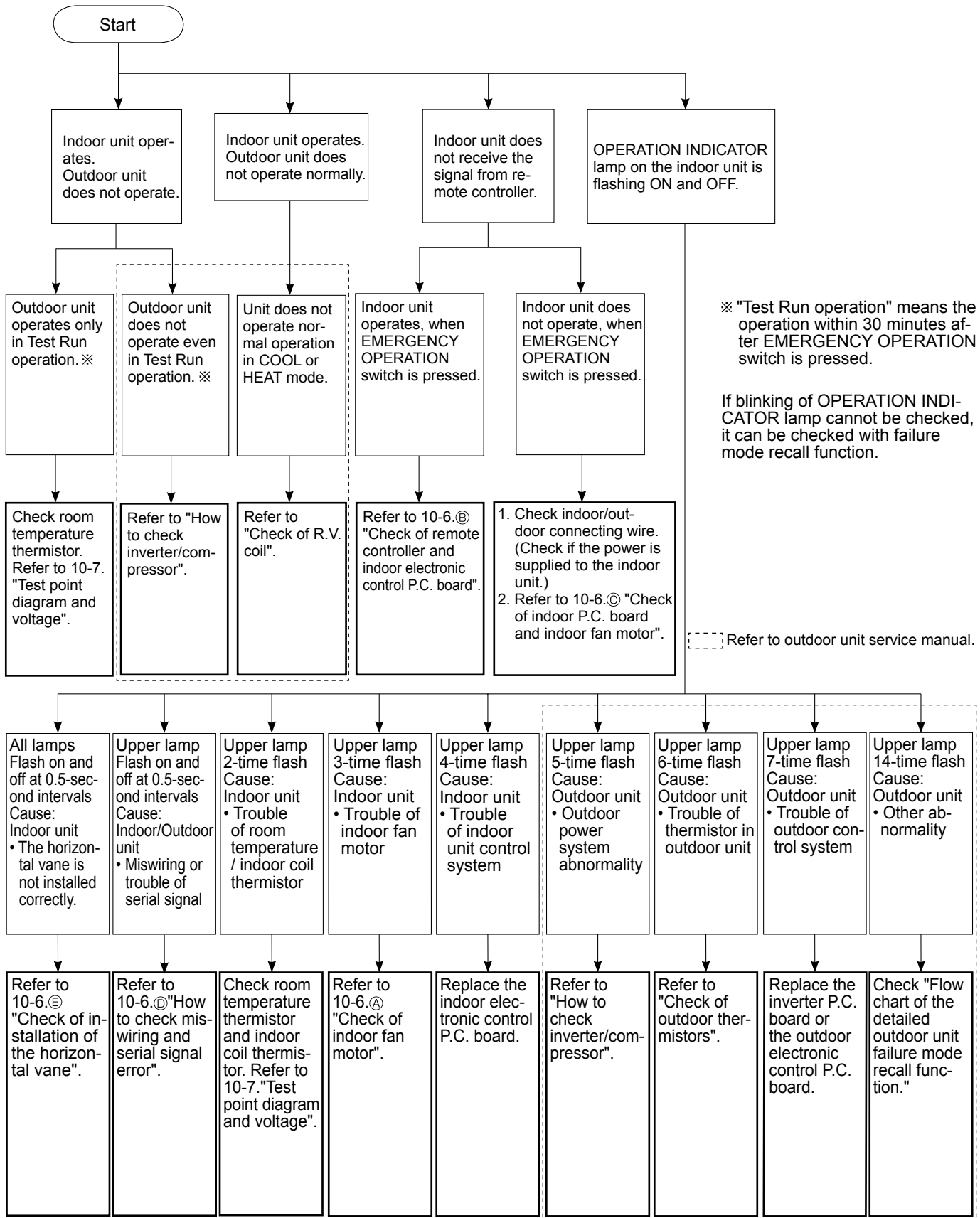





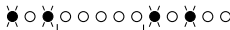
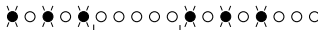
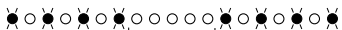

## 10-4. TROUBLESHOOTING CHECK TABLE

Before taking measures, make sure that the symptom reappears for accurate troubleshooting.  
When the indoor unit has started operation and detected an abnormality of the following condition (the first detection after the power ON), the indoor fan motor turns OFF and OPERATION INDICATOR lamp flashes.

### OPERATION INDICATOR



No.	Abnormal point	Operation indicator lamp	Symptom	Condition	Correspondence
1	Miswiring or serial signal	Upper lamp flashes. 0.5-second ON  0.5-second OFF		The serial signal from the outdoor unit is not received for 6 minutes.	• Refer to 10-6. ③ "How to check miswiring and serial signal error".
2	Indoor coil thermistor Room temperature thermistor	Upper lamp flashes. 2-time flash  2.5-second OFF		The indoor coil or the room temperature thermistor is short or open circuit.	• Refer to the characteristics of indoor coil thermistor, and the room temperature thermistor (10-7.2,3.).
3	Indoor fan motor	Upper lamp flashes. 3-time flash  2.5-second OFF		The rotational frequency feedback signal is not emitted during the indoor fan operation.	• Refer to 10-6. ④ "Check of indoor fan motor".
4	Indoor control system	Upper lamp flashes. 4-time flash  2.5-second OFF	Indoor unit and outdoor unit do not operate.	It cannot properly read data in the nonvolatile memory of the indoor electronic control P.C. board.	• Replace the indoor electronic control P.C. board.
5	Outdoor power system	Upper lamp flashes. 5-time flash  2.5-second OFF		It consecutively occurs 3 times that the compressor stops for overcurrent protection or start-up failure protection within 1 minute after start-up.	• Refer to "How to check of inverter/compressor". Refer to outdoor unit service manual • Check the stop valve.
6	Outdoor thermistors	Upper lamp flashes. 6-time flash  2.5-second OFF		The outdoor thermistors short or open circuit during the compressor operation.	• Refer to "Check of outdoor thermistor". Refer to outdoor unit service manual.
7	Outdoor control system	Upper lamp flashes. 7-time flash  2.5-second OFF		It cannot properly read data in the nonvolatile memory of the inverter P.C. board or the outdoor electronic control P.C. board.	• Replace the inverter P.C. board or the outdoor electronic control P.C. board. Refer to outdoor unit service manual.
8	Other abnormality	Upper lamp flashes. 14-time flash  2.5-second OFF		An abnormality other than above mentioned is detected.	• Check the stop valve. • Confirm the abnormality in detail using the failure mode recall function for outdoor unit.
9	Outdoor control system	Upper lamp lights up 	Outdoor unit does not operate	It cannot properly read data in the nonvolatile memory of the inverter P.C. board or the outdoor electronic control P.C. board.	• Check the blinking pattern of the LED on the inverter P.C. board or the outdoor electronic control P.C. board.

OPERATION INDICATOR



No.	Abnormal point	Operation indicator lamp	Symptom	Condition	Correspondence
1	Attachment of the horizontal vane	All lamps flash at the same time. 0.5-second ON  0.5-second OFF	Indoor unit and outdoor unit do not operate.	The electricity is not conducted to the interlock switch (Fan) of the horizontal vane.	• Refer to 10-6. © "Check of installation of the horizontal vane".

OPERATION INDICATOR

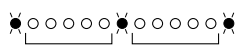

No.	Abnormal point	Operation indicator lamp	Symptom	Condition	Correspondence
1	<b>MXZ type</b> Operation mode setting	Upper lamp lights and lower lamp flashes.  2.5-second OFF	Outdoor unit operates but indoor unit does not operate.	The operation mode of the each indoor unit is differently set to COOL (includes DRY) and HEAT at the same time, the operation mode of the indoor unit that has operated at first has the priority.	• Unify the operation mode. Refer to outdoor unit service manual.

10-5. TROUBLE CRITERION OF MAIN PARTS

**MSZ-GE22VA MSZ-GE25VA MSZ-GE35VA MSZ-GE42VA MSZ-GE50VA  
MSZ-GE60VA MSZ-GE71VA**

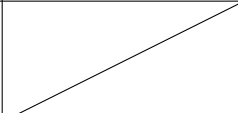
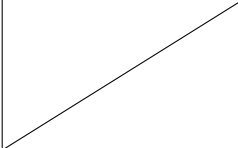
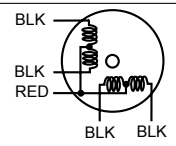
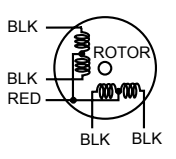
Part name	Check method and criterion	Figure								
Room temperature thermistor (RT11) Indoor coil thermistor (RT12, RT13)	Measure the resistance with a tester. Refer to 10-7. "Test point diagram and voltage", "2 or 3. Indoor electronic control P.C. board", for the chart of thermistor.									
Indoor fan motor (MF)	Check 10-6.④ "Check of indoor fan motor".									
<b>MSZ-GE22VA MSZ-GE25VA MSZ-GE35VA MSZ-GE42VA MSZ-GE50VA</b> Vane motor (MV)	Measure the resistance between the terminals with a tester. (Temperature: 10 - 30°C) <table border="1" data-bbox="391 1579 1045 1646"> <thead> <tr> <th>Color of the lead wire</th> <th>Normal</th> </tr> </thead> <tbody> <tr> <td>RED - BLK</td> <td>223 - 268 Ω</td> </tr> </tbody> </table>	Color of the lead wire	Normal	RED - BLK	223 - 268 Ω					
Color of the lead wire	Normal									
RED - BLK	223 - 268 Ω									
<b>MSZ-GE60VA MSZ-GE71VA</b> Horizontal vane motor (MV1) Vertical vane motor (MV2)	Measure the resistance between the terminals with a tester. (Temperature: 10 - 30°C) <table border="1" data-bbox="391 1758 1181 1859"> <thead> <tr> <th></th> <th>Color of the lead wire</th> <th>Normal</th> </tr> </thead> <tbody> <tr> <td>Horizontal vane motor (MV1)</td> <td rowspan="2">RED-BLK</td> <td>313 ~ 375 Ω</td> </tr> <tr> <td>Vertical vane motor (MV2)</td> <td>268 ~ 322 Ω</td> </tr> </tbody> </table>		Color of the lead wire	Normal	Horizontal vane motor (MV1)	RED-BLK	313 ~ 375 Ω	Vertical vane motor (MV2)	268 ~ 322 Ω	
	Color of the lead wire	Normal								
Horizontal vane motor (MV1)	RED-BLK	313 ~ 375 Ω								
Vertical vane motor (MV2)		268 ~ 322 Ω								

## 10-6. TROUBLESHOOTING FLOW

### A Check of indoor fan motor

#### MSZ-GE22VA MSZ-GE25VA MSZ-GE35VA MSZ-GE42VA MSZ-GE50VA

The indoor fan motor error has occurred, and the indoor fan does not operate.

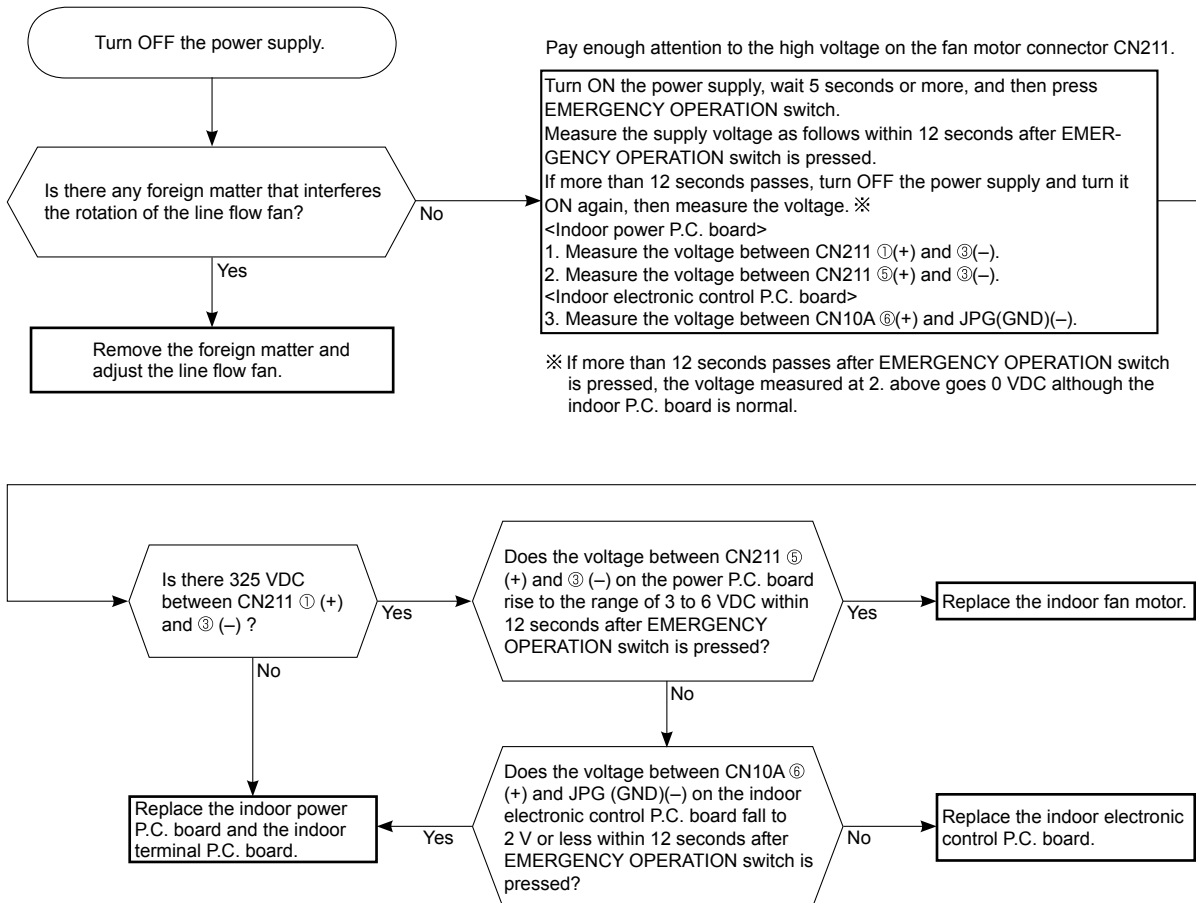

The indoor fan motor error has occurred, and the indoor fan repeats "12-second ON and 30-second OFF" 3 times, and then stops.

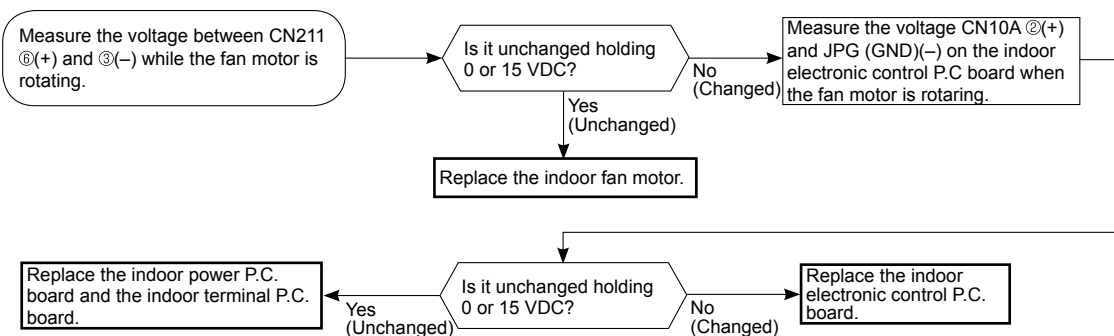

## MSZ-GE60VA MSZ-GE71VA

The indoor fan motor error has occurred, and the indoor fan does not operate.

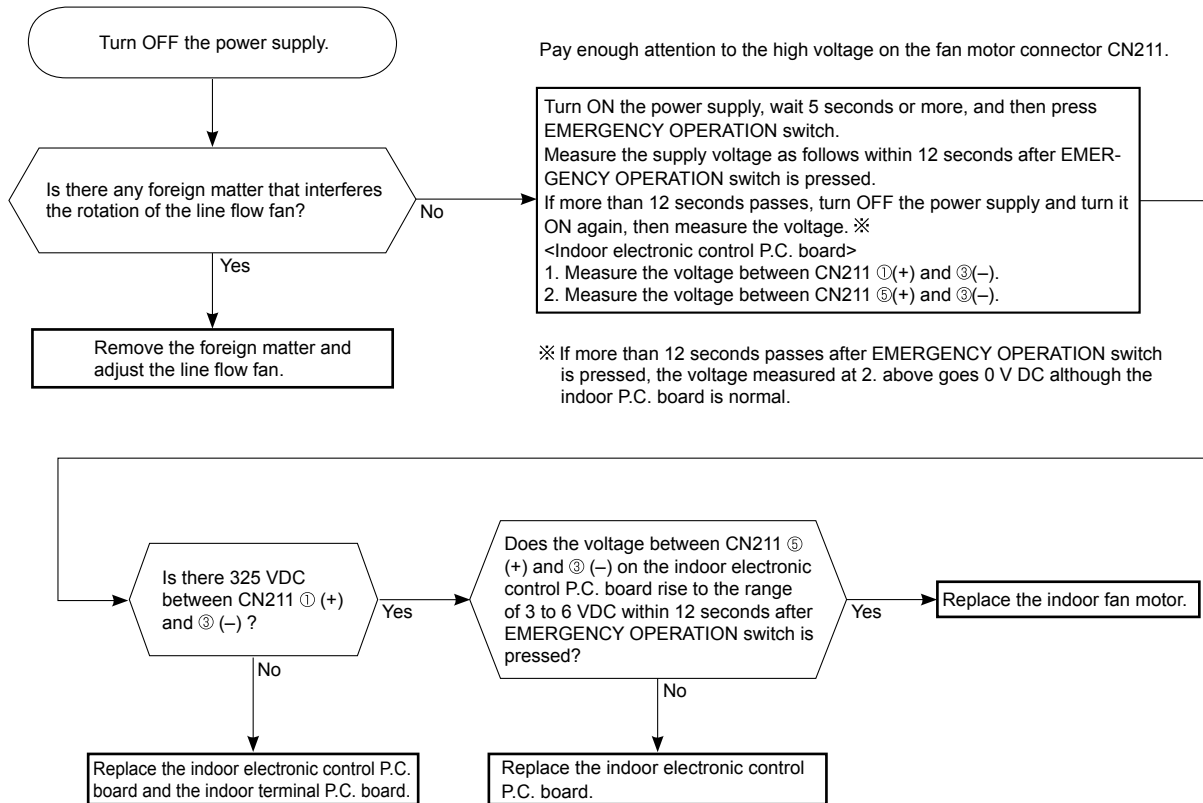

The indoor fan motor error has occurred, and the indoor fan repeats "12-second ON and 30-second OFF" 3 times, and then stops.

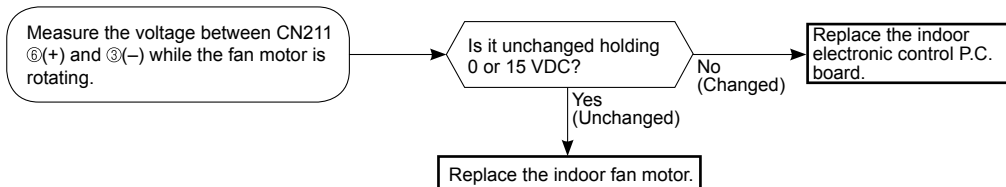

## B Check of remote controller and indoor electronic control P.C. board

※Check if the remote controller is exclusive for this air conditioner.

### MSZ-GE22VA MSZ-GE25VA MSZ-GE35VA MSZ-GE42VA MSZ-GE50VA

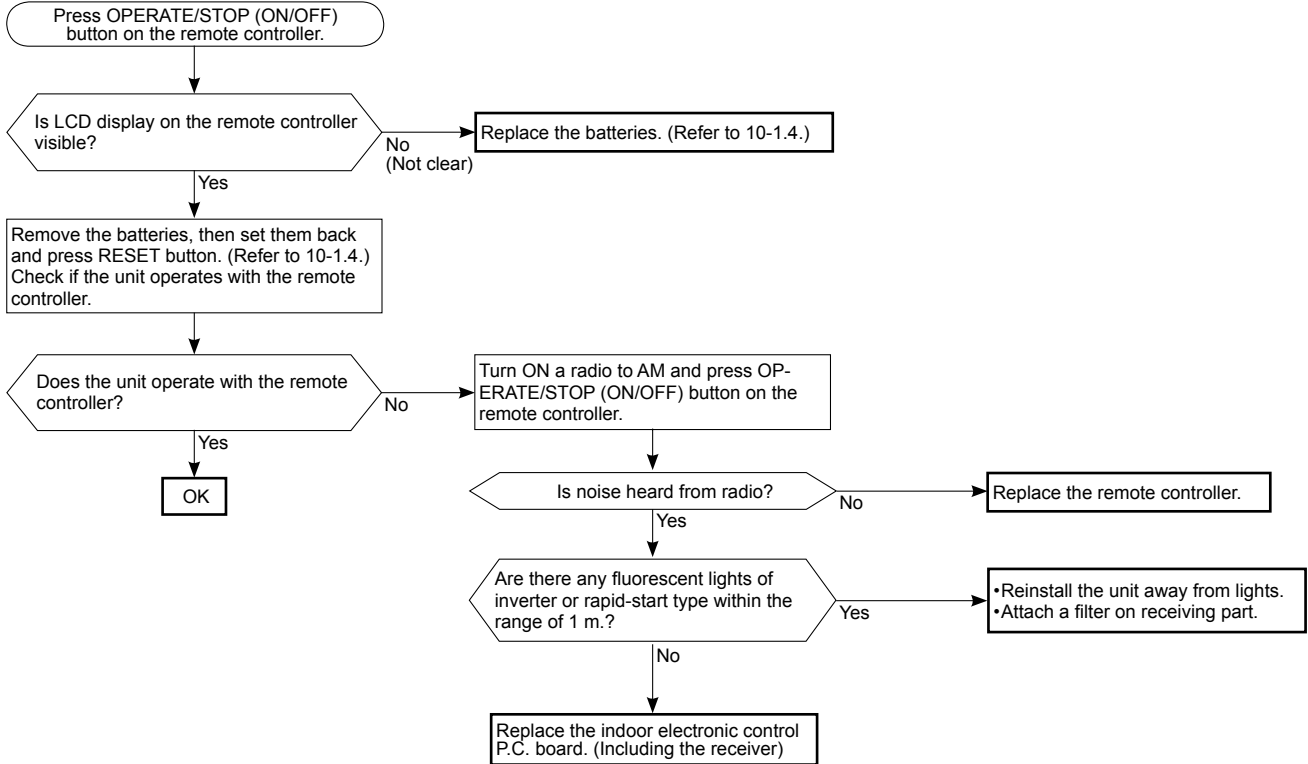

### MSZ-GE60VA MSZ-GE71VA

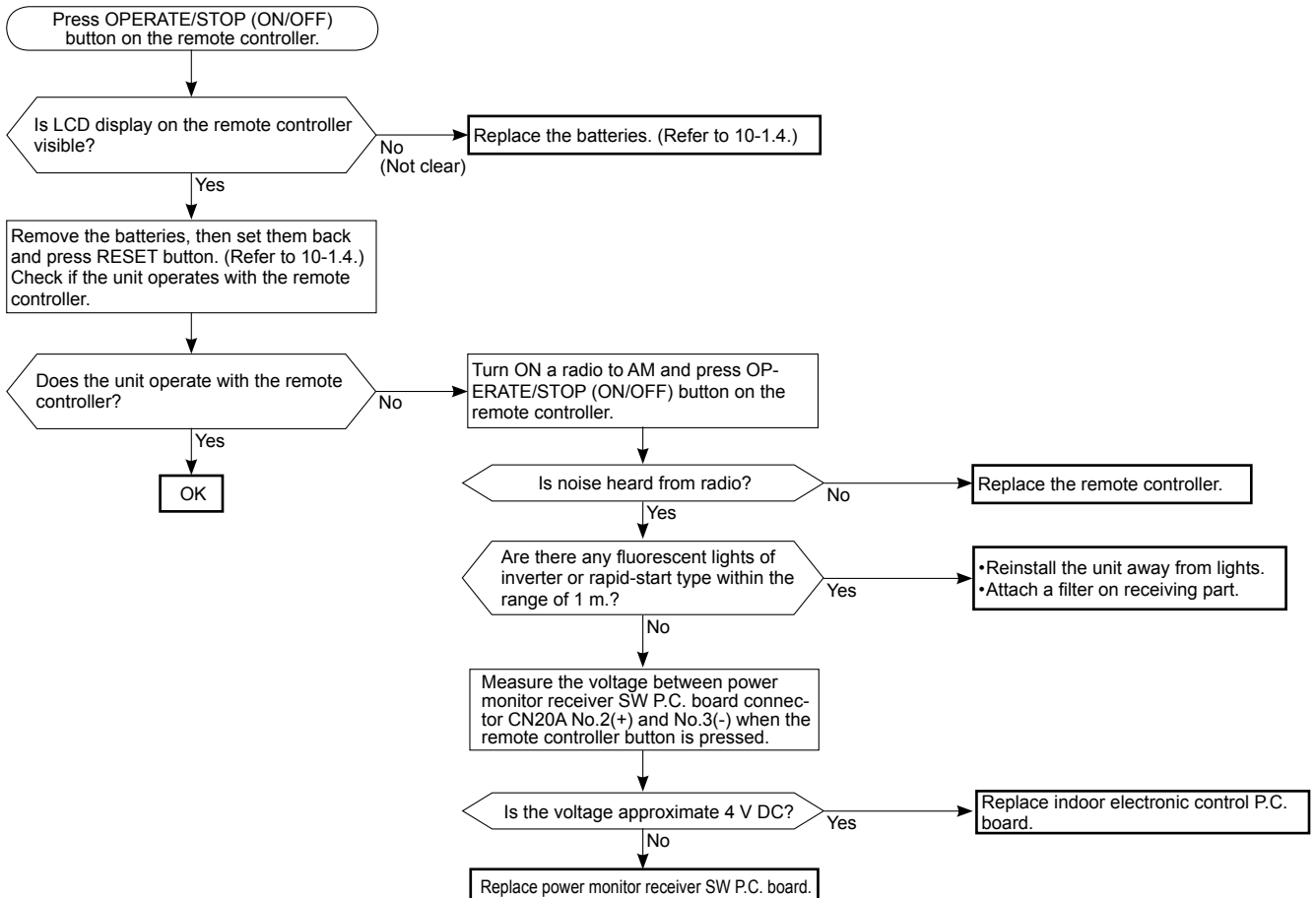

## © Check of indoor P.C. board and indoor fan motor

MSZ-GE22VA MSZ-GE25VA MSZ-GE35VA MSZ-GE42VA MSZ-GE50VA

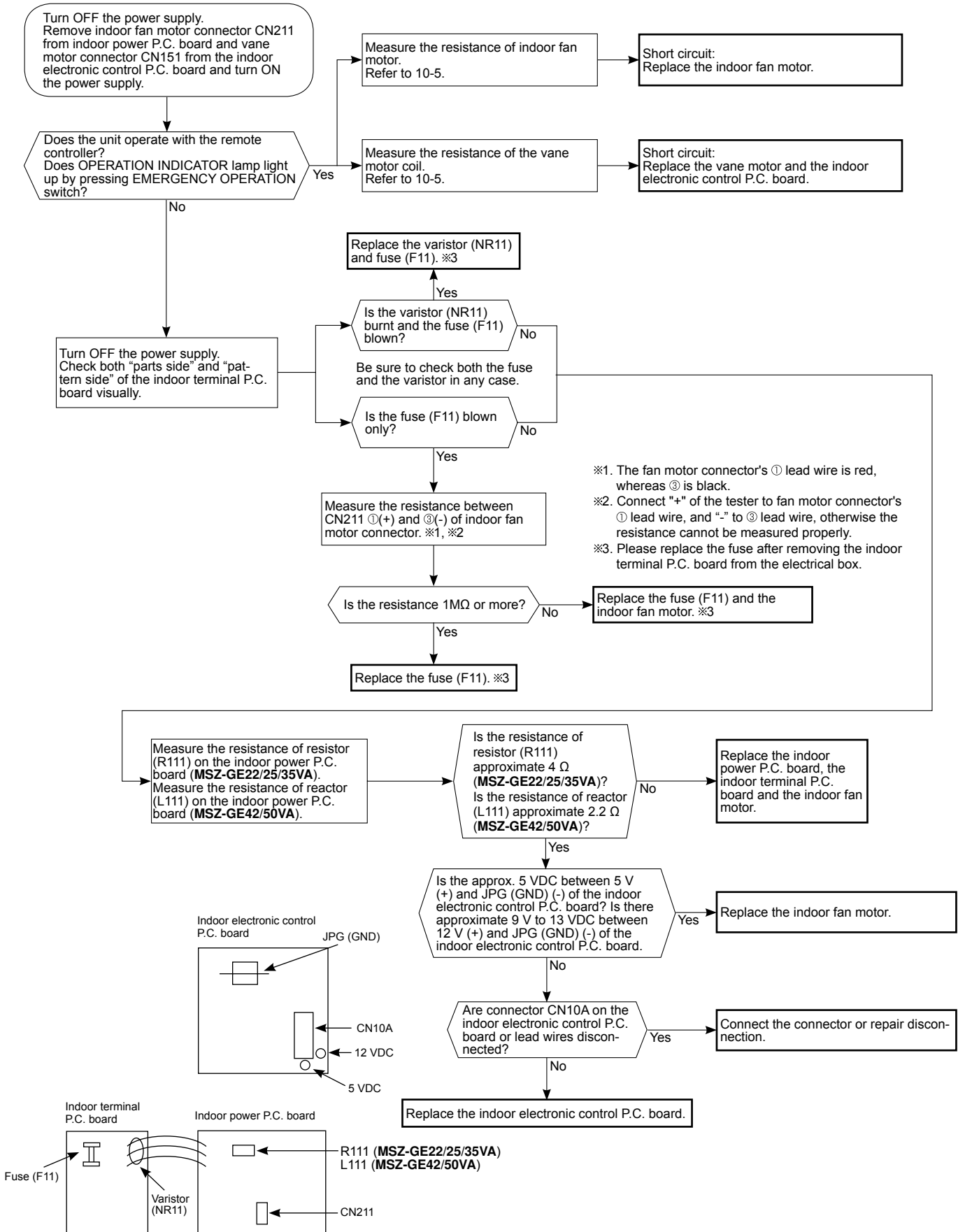

# MSZ-GE60VA MSZ-GE71VA

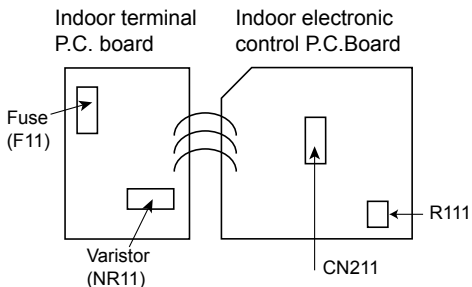
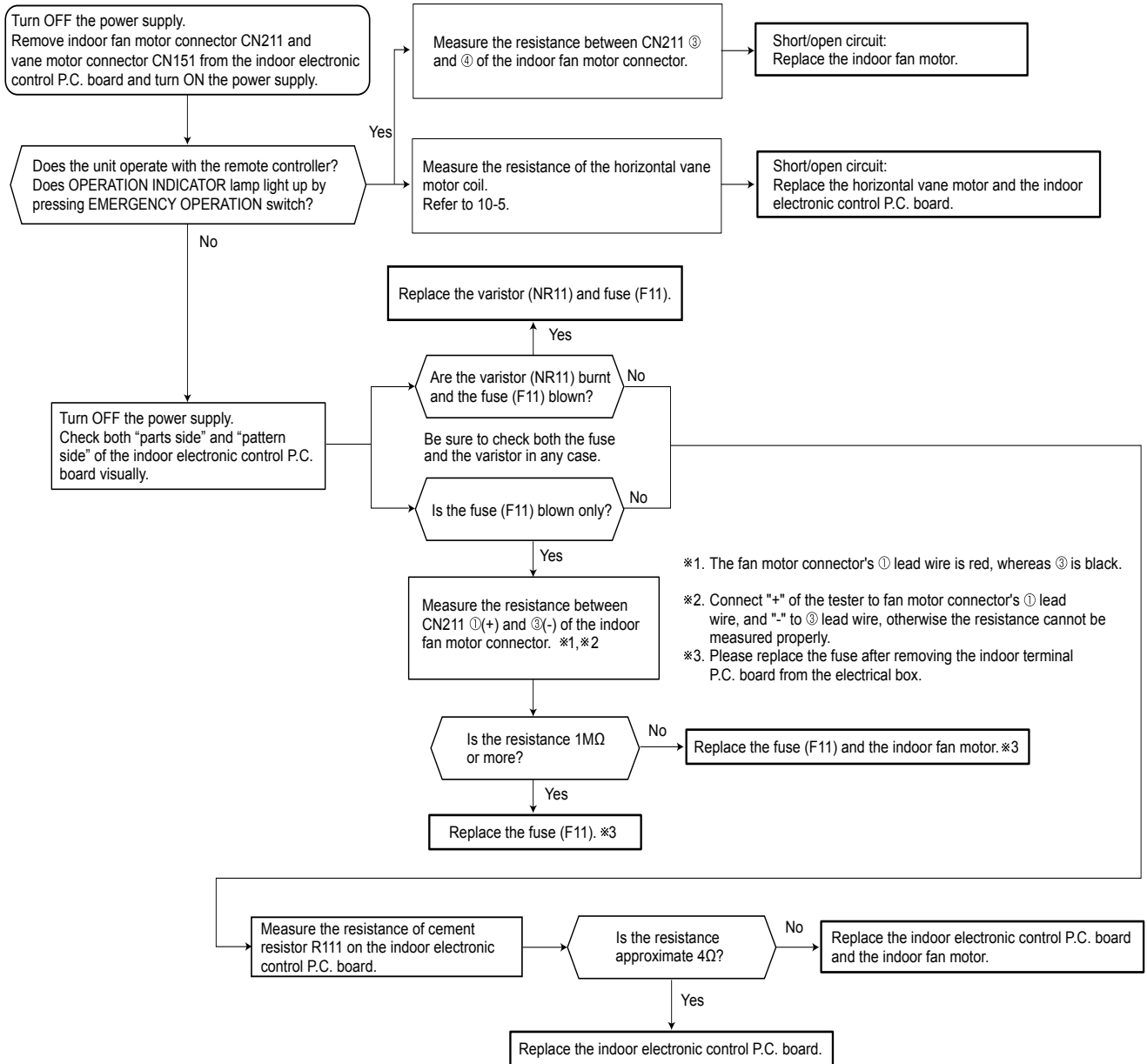

## D How to check miswiring and serial signal error

MSZ-GE22VA MSZ-GE25VA MSZ-GE35VA MSZ-GE42VA MSZ-GE50VA

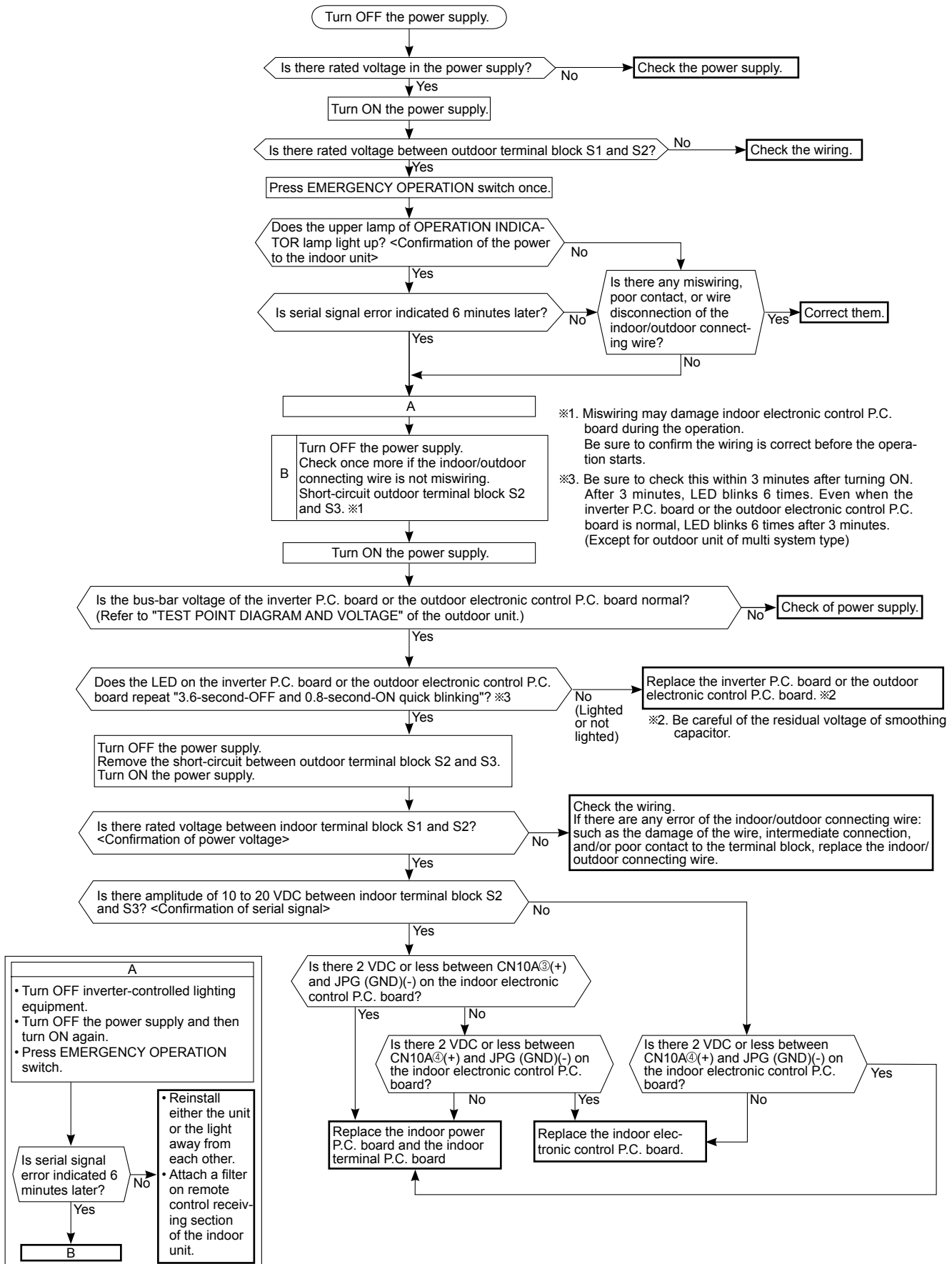

**MSZ-GE60VA MSZ-GE71VA**

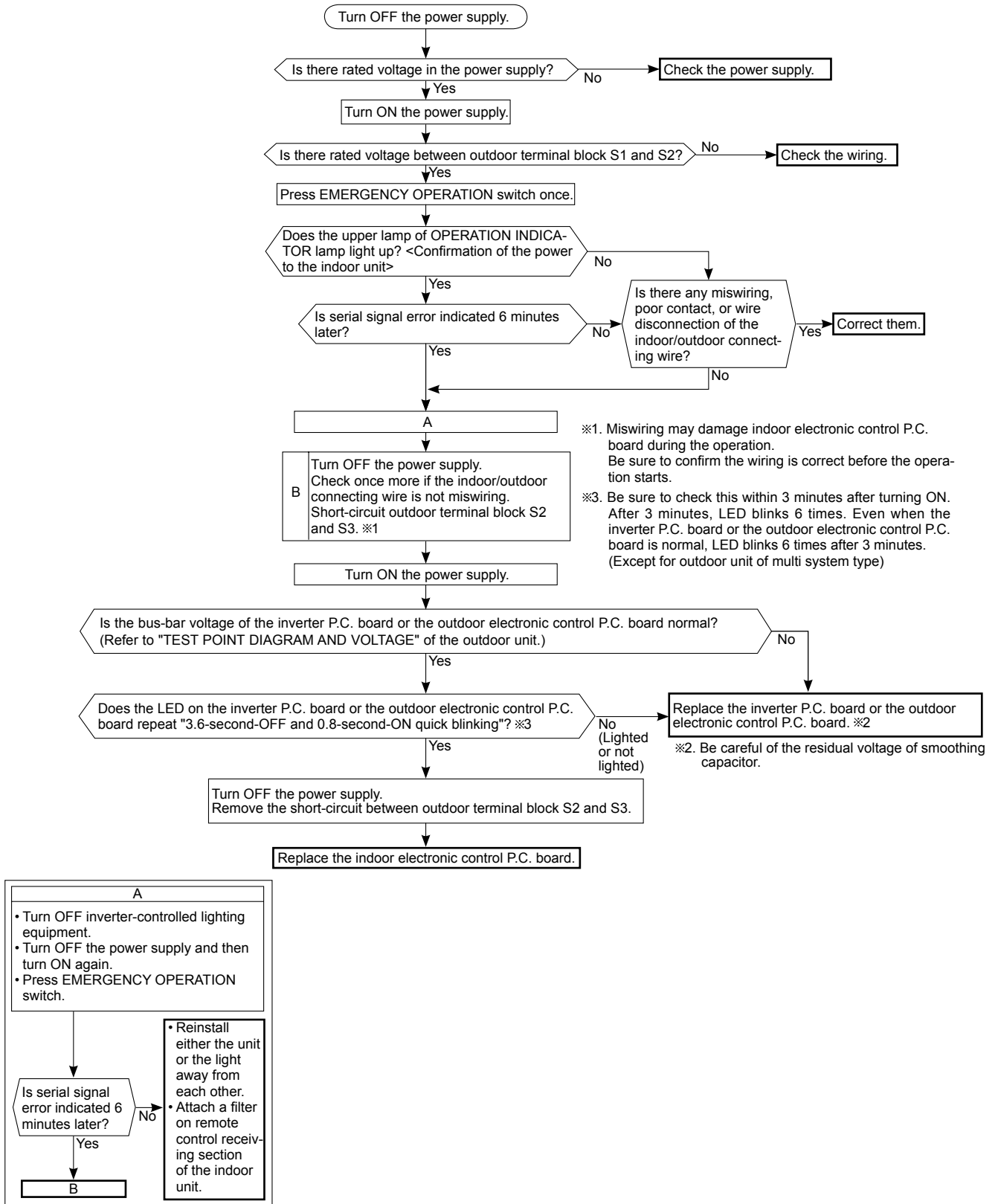

## E Check of installation of the horizontal vane

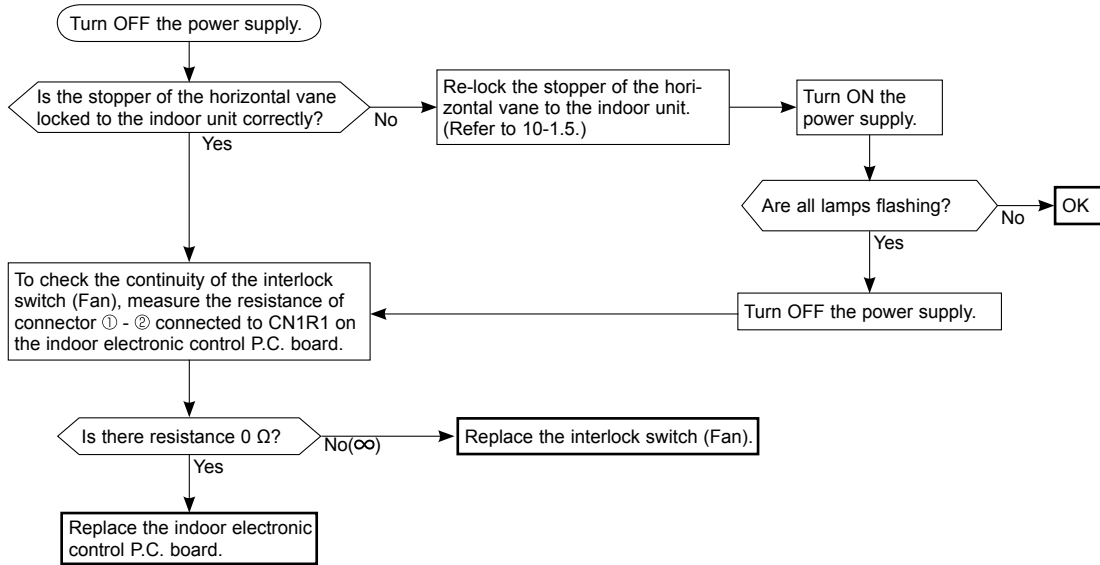

## F Electromagnetic noise enters into TV sets or radios

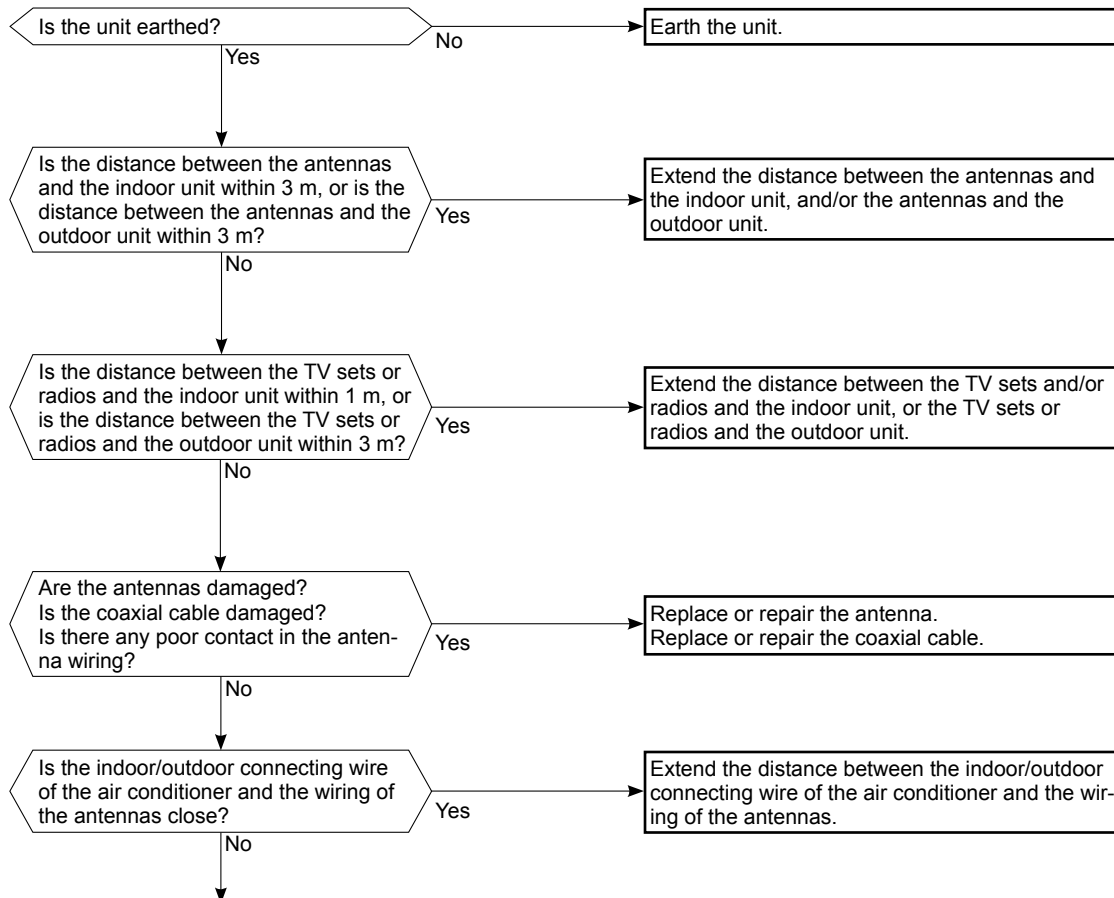

Even if all of the above conditions are fulfilled, the electromagnetic noise may enter, depending on the electric field strength or the installation condition (combination of specific conditions such as antennas or wiring).  
Check the following before asking for service.

1. Devices affected by the electromagnetic noise  
TV sets, radios (FM/AM broadcast, shortwave)
2. Channel, frequency, broadcast station affected by the electromagnetic noise
3. Channel, frequency, broadcast station unaffected by the electromagnetic noise
4. Layout of:  
indoor/outdoor unit of the air conditioner, indoor/outdoor wiring, earth wire, antennas, wiring from antennas, receiver
5. Electric field intensity of the broadcast station affected by the electromagnetic noise
6. Presence or absence of amplifier such as booster
7. Operation condition of air conditioner when the electromagnetic noise enters in
  - 1) Turn OFF the power supply once, and then turn ON the power supply. In this situation, check for the electromagnetic noise.
  - 2) Within 3 minutes after turning ON the power supply, press OPERATE/STOP (ON/OFF) button on the remote controller for power ON, and check for the electromagnetic noise.
  - 3) After a short time (3 minutes later after turning ON), the outdoor unit starts running. During operation, check for the electromagnetic noise.
  - 4) Press OPERATE/STOP (ON/OFF) button on the remote controller for power OFF, when the outdoor unit stops but the indoor/outdoor communication still runs on. In this situation, check for the electromagnetic noise.

## 10-7. TEST POINT DIAGRAM AND VOLTAGE

### 1. Indoor power P.C. board, Indoor terminal P.C. board MSZ-GE22VA MSZ-GE25VA MSZ-GE35VA

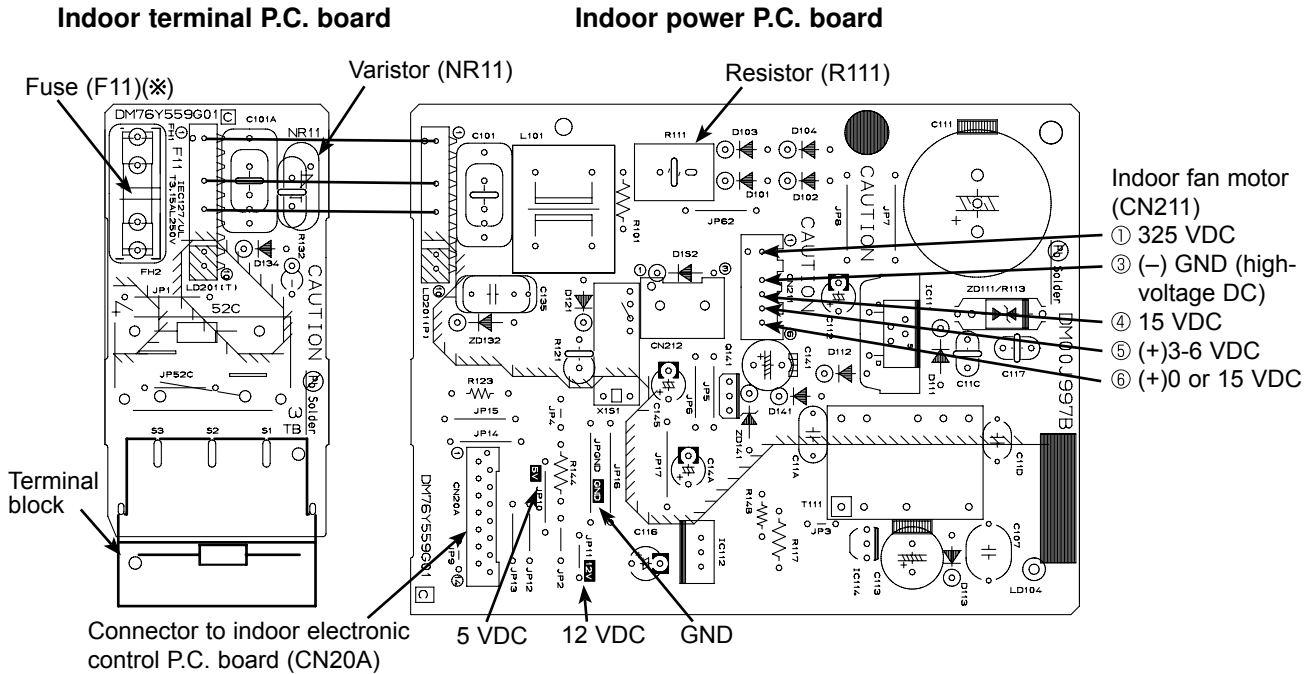

\* Please replace the fuse after removing the indoor terminal P.C. board from the electrical box.

### MSZ-GE42VA MSZ-GE50VA

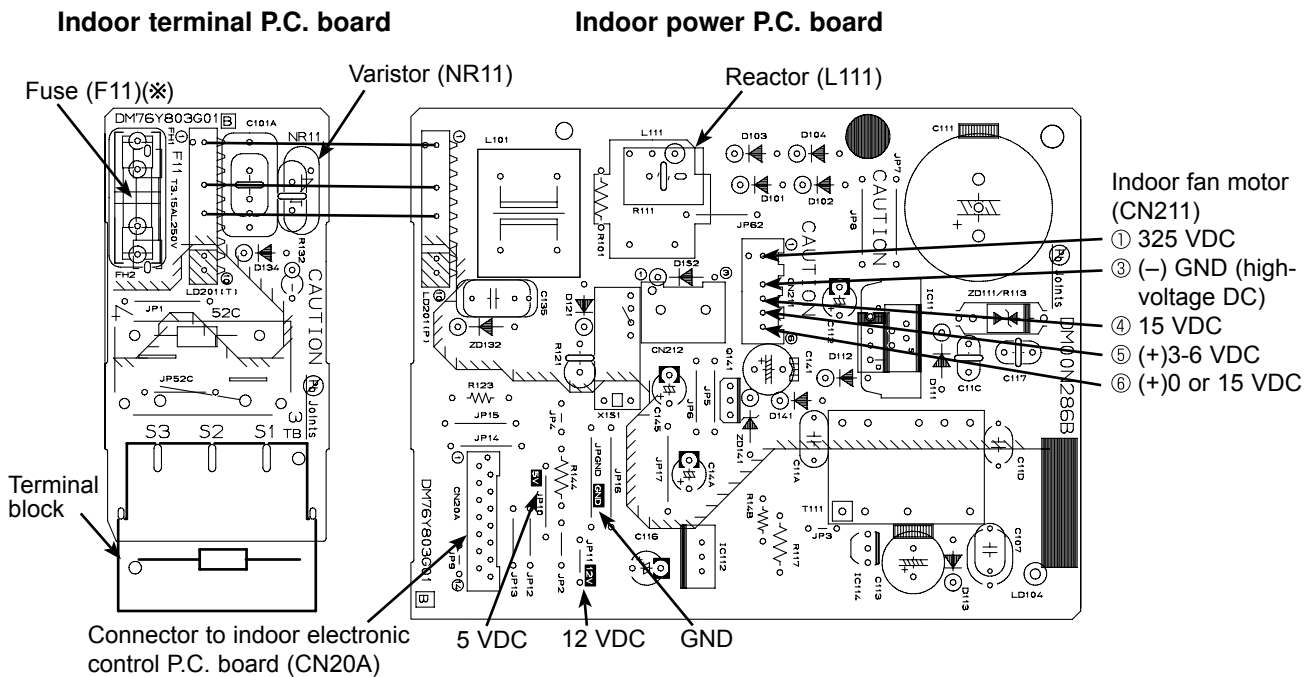

\* Please replace the fuse after removing the indoor terminal P.C. board from the electrical box.

**2. Indoor electronic control P.C. board**  
**MSZ-GE22VA MSZ-GE25VA MSZ-GE35VA MSZ-GE42VA MSZ-GE50VA**

**Indoor electronic control P.C. board**

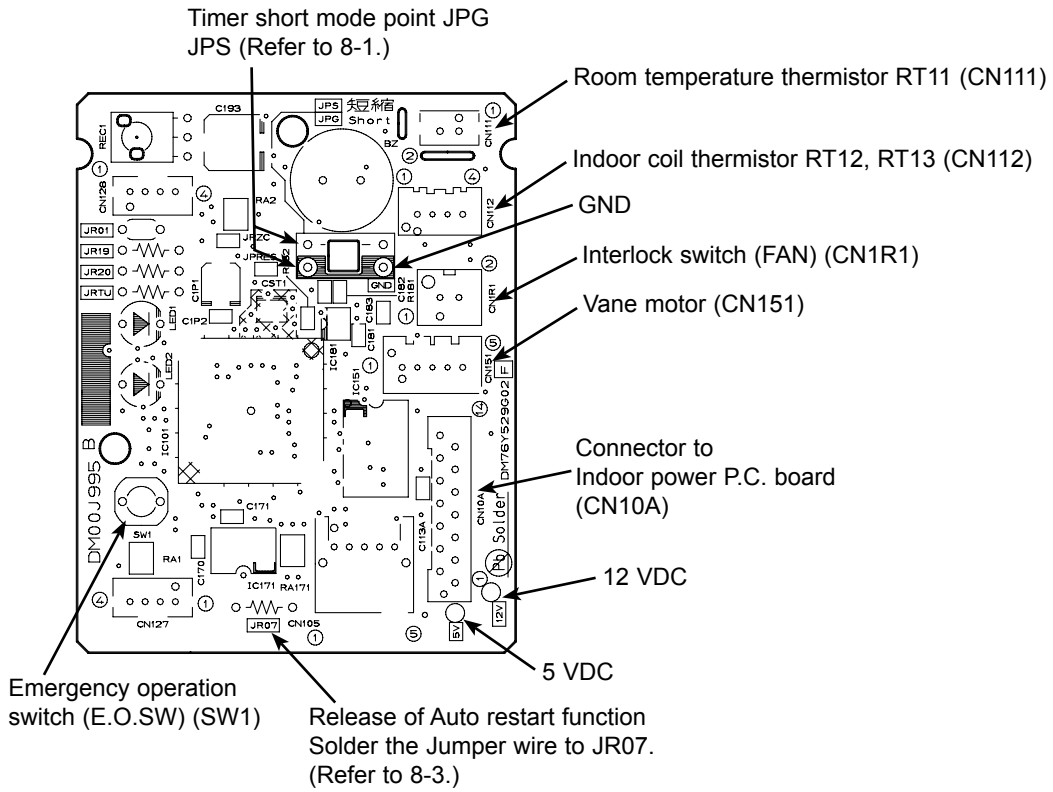

**Room temperature thermistor (RT11)**  
**Indoor coil thermistor (RT12, RT13)**

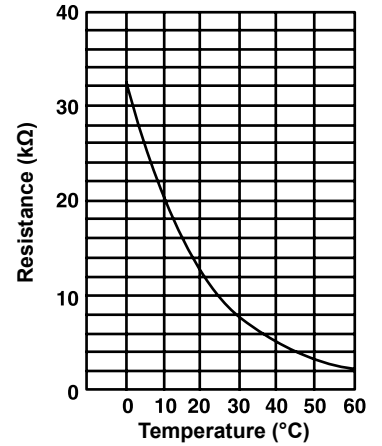

### 3. Indoor electronic control P.C. board, Indoor terminal P.C. board, Power monitor receiver SW P.C. board MSZ-GE60VA MSZ-GE71VA

#### Indoor terminal P.C. board

#### Indoor electronic control P.C. board

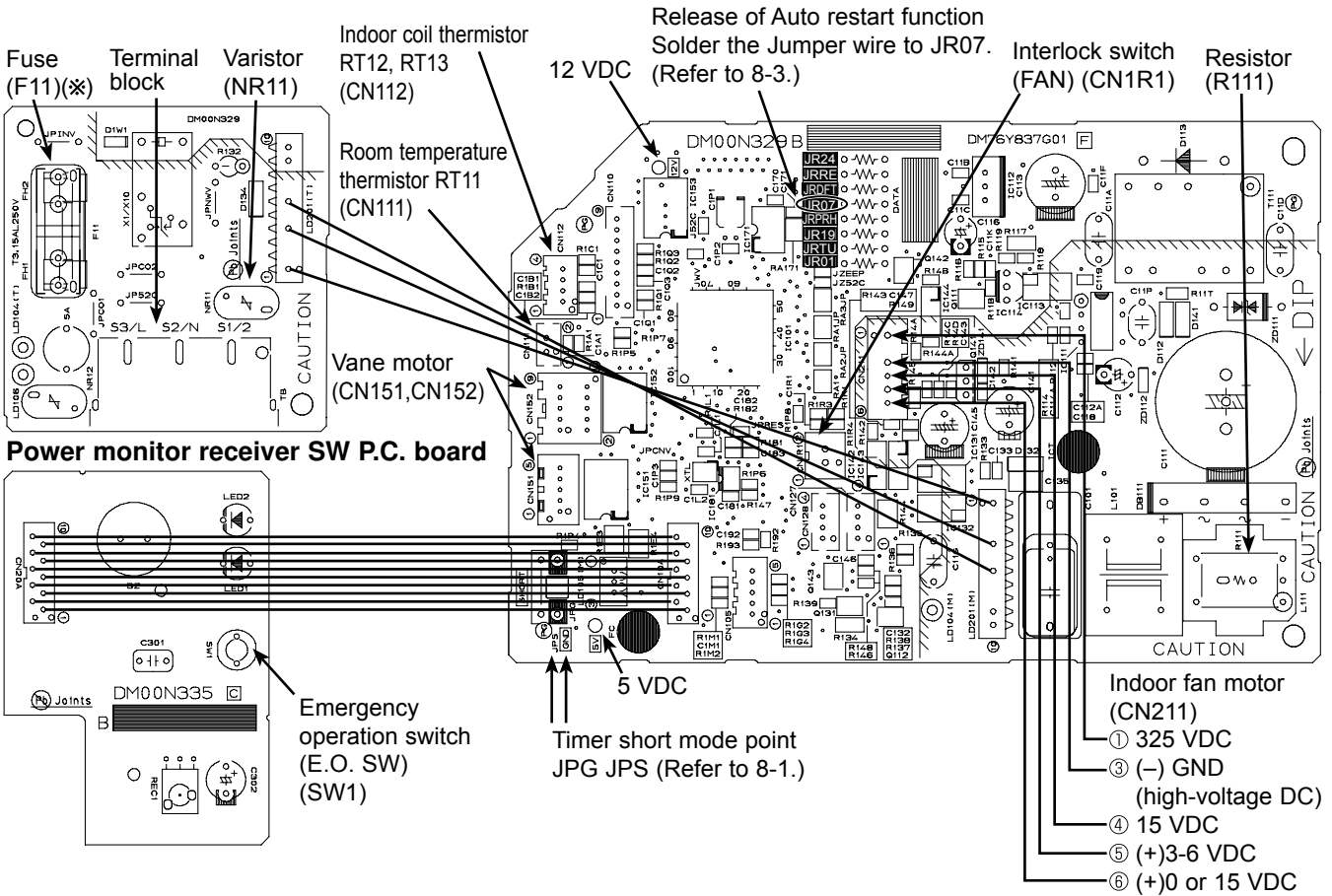

※ Please replace the fuse after removing the indoor terminal P.C. board from the electrical box.

**Room temperature thermistor (RT11)  
Indoor coil thermistor (RT12, RT13)**

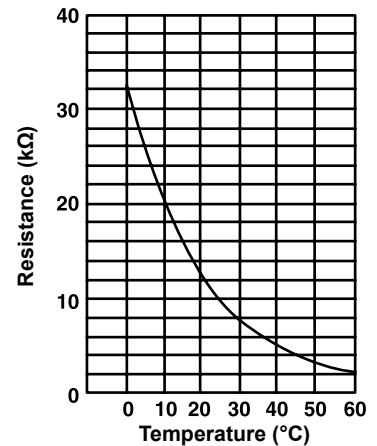

## &lt;"Terminal with locking mechanism" Detaching points&gt;

The terminal which has the locking mechanism can be detached as shown below.  
There are two types (Refer to (1) and (2)) of the terminal with locking mechanism.  
The terminal without locking mechanism can be detached by pulling it out.  
Check the shape of the terminal before detaching.

(1) Slide the sleeve and check if there is a locking lever or not.

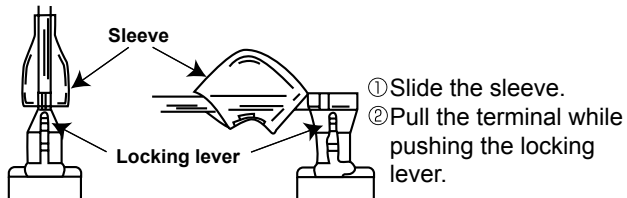

(2) The terminal with this connector has the locking mechanism.

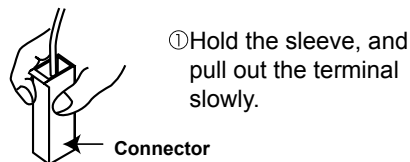

## 11-1. MSZ-GE22VA MSZ-GE25VA MSZ-GE35VA MSZ-GE42VA MSZ-GE50VA

NOTE: Turn OFF power supply before disassembling.

OPERATING PROCEDURE	PHOTOS
<p><b>1. Removing the panel</b></p> <ol style="list-style-type: none"> <li>(1) Remove the horizontal vanes.</li> <li>(2) Remove the screw caps of the panel. Remove the screws of the panel.</li> <li>(3) Unhook the lower part (A) of the panel.</li> <li>(4) Hold the lower part of both ends of the panel and pull it slightly toward you, and then remove the panel by pushing it upward.</li> </ol>	<p><b>Photo 1</b></p>

## OPERATING PROCEDURE

### 2. Removing the indoor electronic control P.C. board and the room temperature thermistor

- (1) Remove the panel (Refer to 1.) and the corner box.
- (2) Remove the screw of the V.A. clamp. Remove the V.A. clamp and the indoor/outdoor connecting wire.
- (3) Open the indoor electronic control P.C. board holder (to right side)
- (4) Disconnect the following connectors:  
<Indoor electronic control P.C. board>  
CN112 (Indoor coil thermistor)  
CN151 (Vane motor)  
CN1R1 (Interlock switch)  
CN10A (To the indoor power P.C. board)
- (5) Unhook the catches of the indoor electronic control P.C. board holder from the nozzle and the electrical box (right side).
- (6) Remove the room temperature thermistor from the hook of the indoor electronic control P.C. board holder.
- (7) Open the back side of the indoor electronic control P.C. board holder, and remove the indoor electronic control P.C. board.
- (8) Remove the room temperature thermistor from the indoor electronic control P.C. board.

### 3. Remove the indoor power P.C. board, the indoor terminal P.C. board, and the electrical box

- (1) Remove the panel (Refer to 1.) and the corner box.
- (2) Remove the indoor/outdoor connecting wire. (Refer to 2.)
- (3) Remove the earth wire connected to the indoor heat exchanger from the electrical box.
- (4) Unhook first the lower, then the upper catches of the electrical box, and pull out the electrical box.
- (5) Remove the screw of the electrical cover and remove the electrical cover.
- (6) Disconnect all the connectors on the indoor power P.C. board and unhook all lead wires.
- (7) Remove the screw of terminal block on the indoor terminal P.C. board.
- (8) Remove the indoor power P.C. board and the indoor terminal P.C. board.

## PHOTOS

Photo 2

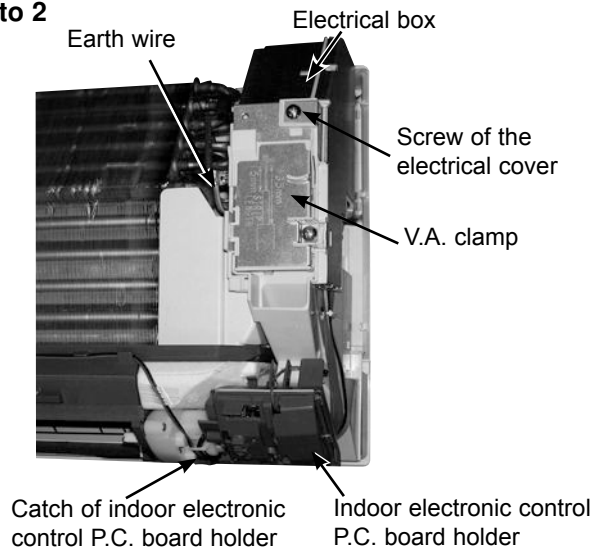
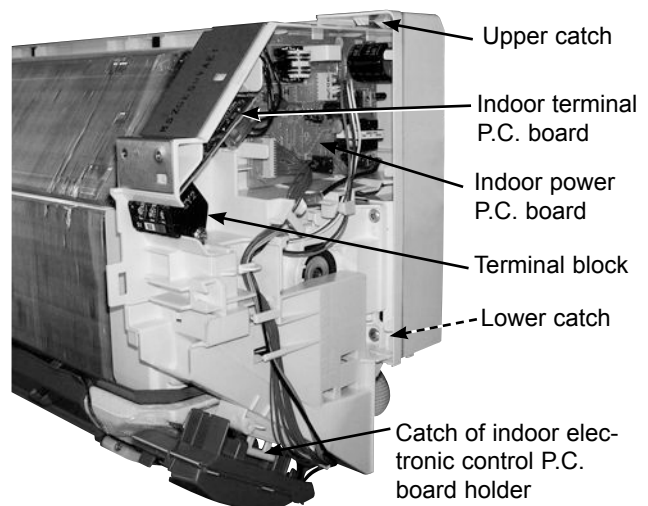

Photo 3



## OPERATING PROCEDURE

### 4. Removing the nozzle assembly

- (1) Remove the panel (Refer to 1.) and the corner box.
- (2) Remove the indoor/outdoor connecting wire. (Refer to 2.)
- (3) Remove the indoor electronic control P.C. board holder
- (4) Disconnect the following connectors:  
<Indoor electronic control P.C. board>  
CN1R1 (Interlock switch)
- (5) Pull out the drain hose from the nozzle assembly and remove the nozzle assembly.
- (6) Remove the interlock switch.

### 5. Removing the horizontal vane motor

- (1) Remove the nozzle assembly. (Refer to 4.)
- (2) Remove the screws of the horizontal vane motor unit.
- (3) Disconnect the connector from the horizontal vane motor.
- (4) Remove the screws of the horizontal vane motor.
- (5) Remove the horizontal vane motor from the horizontal vane motor unit.

## PHOTOS

Photo 4

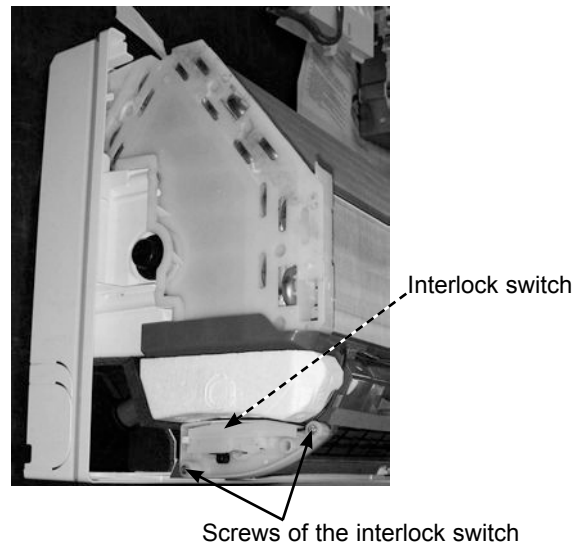
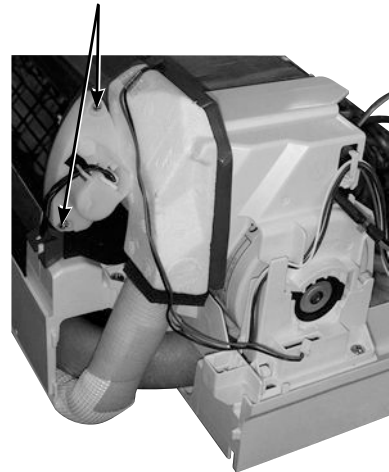

Photo 5

Screws of horizontal vane motor unit



## OPERATING PROCEDURE

### 6. Removing the indoor fan motor, the indoor coil thermistor, and the line flow fan

- (1) Remove the panel (Refer to 1.) and the corner box.
- (2) Remove the indoor electronic control P.C. board holder, the electrical box and the nozzle assembly.
- (3) Remove the screws fixing the motor bed.
- (4) Loosen the screw fixing the line flow fan.
- (5) Remove the motor bed together with fan motor and motor band.
- (6) Release the hooks of the motor band. Remove the motor band. Pull out the indoor fan motor.
- (8) Remove the indoor coil thermistor from the heat exchanger.  
\* Install the indoor coil thermistor in its former position when assembling it. (Photo 9)
- (9) Remove the screws fixing the left side of the heat exchanger.
- (10) Lift the heat exchanger, and pull out the line flow fan to the lower-left.

Photo 9

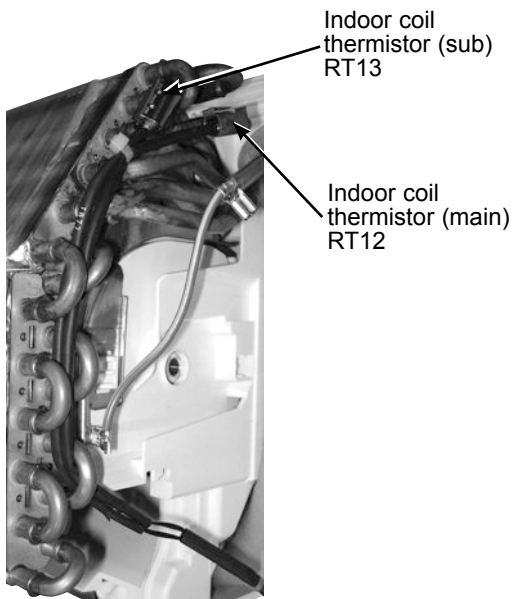

## PHOTOS

Photo 6

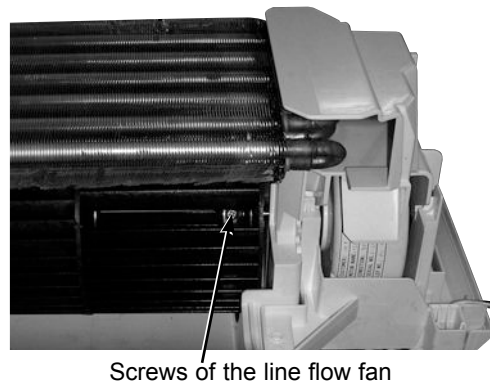

Photo 7

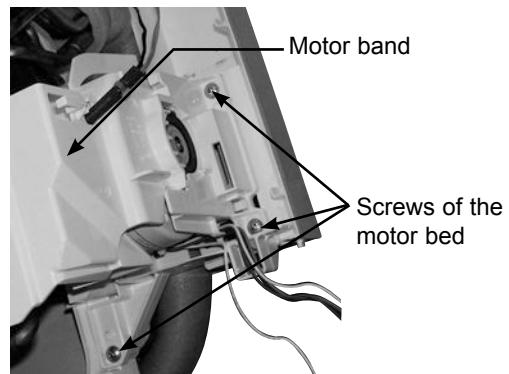
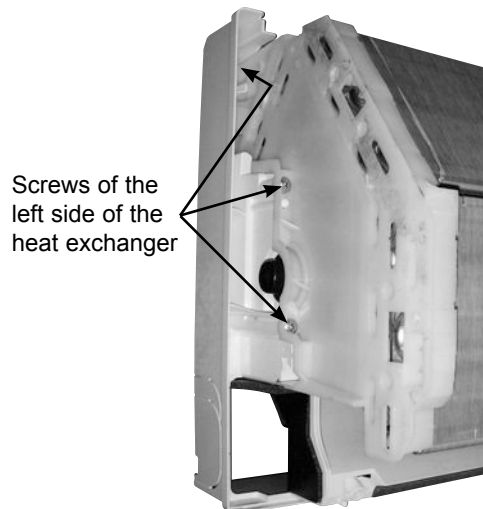
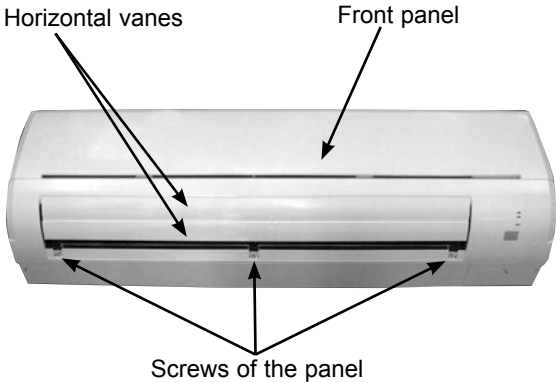

Photo 8



## 11-2. MSZ-GE60VA MSZ-GE71VA

**NOTE:** Turn OFF power supply before disassembling.

OPERATING PROCEDURE	PHOTOS
<p><b>1. Removing the panel</b></p> <ol style="list-style-type: none"><li>(1) Remove the horizontal vanes.</li><li>(2) Remove the screw caps of the panel. Remove the screws of the panel.</li><li>(3) Hold the lower part of both ends of the panel and pull it slightly toward you, and then remove the panel by pushing it upward.</li></ol>	<p><b>Photo 1</b></p>  <p>Horizontal vanes</p> <p>Front panel</p> <p>Screws of the panel</p>

## OPERATING PROCEDURE

### 2. Removing the indoor electronic control P.C. board, the power monitor receiver SW P.C. board and the indoor terminal P.C. board

- (1) Remove the panel (Refer to 1.) and the corner box.
- (2) Remove the screw of the V.A. clamp.  
Remove the V.A. clamp and the indoor/outdoor connecting wire. (Photo 2)
- (3) Remove the screw of the electrical cover, and then the electrical cover.
- (4) Remove the earth wire connected to the indoor electronic control P.C. board from the electrical box. (Photo 3)
- (5) Remove the power monitor receiver holder.
- (6) Open the rear cover of the power monitor receiver holder and pull out the power monitor receiver SW P.C. board.
- (7) Disconnect all the connectors on the indoor electronic control P.C. board and unhook all lead wires.
- (8) Remove the screw of the terminal block on the indoor terminal P.C. board.
- (9) Remove the indoor terminal P.C. board and the indoor electronic control P.C. board.

### 3. Removing the indoor electrical box

- (1) Remove the panel (Refer to 1.) and the corner box.
- (2) Remove the indoor/outdoor connecting wire. (Refer to 2.)
- (3) Remove the earth wire connected to the indoor heat exchanger from the electrical box.
- (4) Remove the screw of the electrical cover and remove the electrical cover.
- (5) Disconnect all the connectors on the indoor electronic control P.C. board and unhook all lead wires.
- (6) Remove the screw fixing the electrical box, then the upper catch of the electrical box, and pull out the electrical box.

## PHOTOS

Photo 2

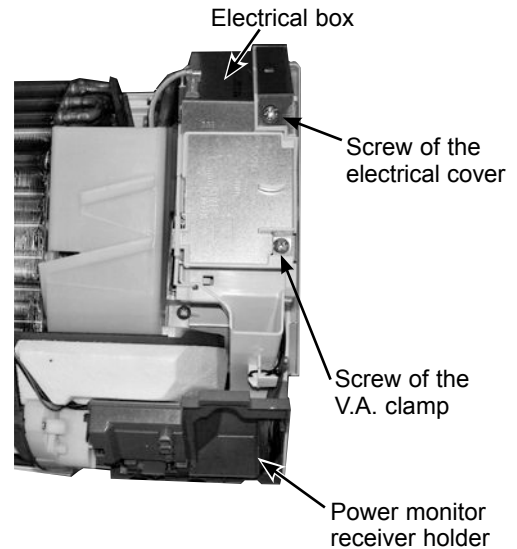
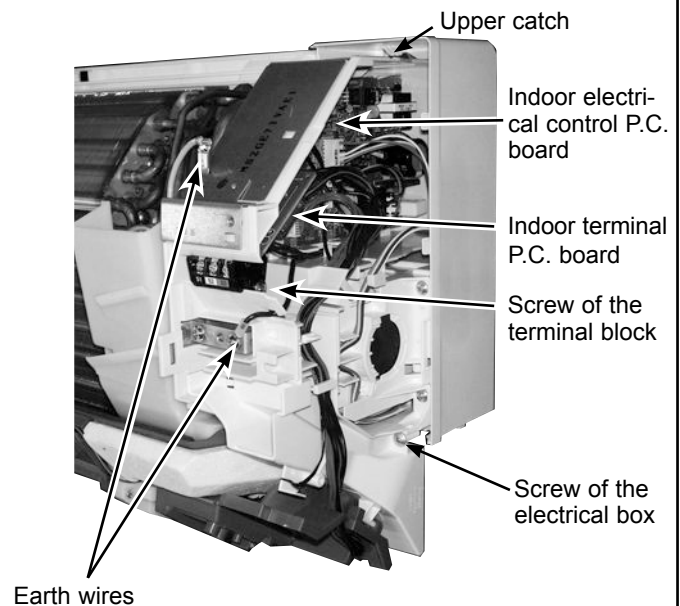

Photo 3



## OPERATING PROCEDURE

### 4. Removing the nozzle assembly

- (1) Remove the panel (Refer to 1.) and the corner box.
- (2) Remove the V.A. clamp, and then the indoor/outdoor connecting wire. (Photo 2)
- (3) Remove the electrical cover. (Photo 2)
- (4) Disconnect the following connectors on the electronic control P.C. board:  
CN151 (Horizontal vane motor)  
CN152 (Vertical vane motor)  
CN1R1 (Interlock switch)
- (5) Remove the power monitor receiver holder. (Photo 4)
- (6) Pull out the drain hose from the nozzle assembly and remove the nozzle assembly.
- (7) Remove the vane motors. (Refer to 5 and 6.)
- (8) Remove the interlock switch.

### 5. Removing the vertical vane motor unit

- (1) Remove the nozzle assembly. (Refer to 4.)
- (2) Remove the crank of the vertical vane motor unit from the arm of the vertical vane.
- (3) Remove the screw of the vertical vane motor unit, and pull the vertical vane motor unit.
- (4) Remove the screws of the vertical vane motor unit cover.
- (5) Remove the crank of the vertical vane motor unit from the shaft of the vane motor.
- (6) Remove the vertical vane motor from the vertical vane motor unit.
- (7) Disconnect the connector of vertical vane motor from the vertical vane motor.

### 6. Removing the horizontal vane motor

- (1) Remove the nozzle assembly. (Refer to 4.)
- (2) Remove the screws of the horizontal vane motor unit, and pull out the horizontal vane motor unit.
- (3) Disconnect the connector from the horizontal vane motor.
- (4) Remove the screws of the horizontal vane motor unit cover.
- (5) Remove the horizontal vane motor from the horizontal vane motor unit.

## PHOTOS

Photo 4



Screws of  
the vertical vane  
motor unit

Screws of  
the interlock switch

Photo 5

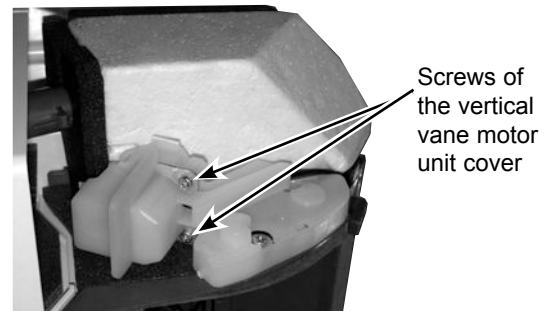

Screws of  
the vertical  
vane motor  
unit cover

Photo 6

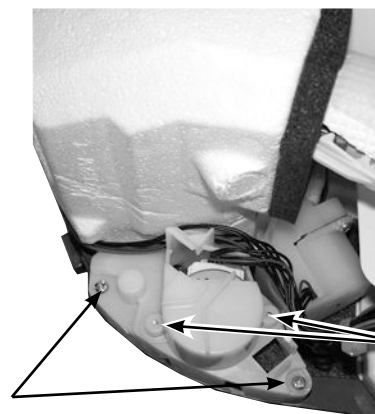

Screws of  
the horizontal  
vane motor  
unit

Screws of  
the horizontal  
vane motor  
unit cover

## OPERATING PROCEDURE

### 7. Removing the water cut, the indoor fan motor, the indoor coil thermistor, and the line flow fan

- (1) Remove the panel (Refer to 1.) and the corner box.
- (2) Remove the power monitor receiver holder, the electrical box and the nozzle assembly. (Refer to 3 and 4.)
- (3) Remove the screw of the water cut and remove the water cut.
- (4) Remove the screws fixing the motor bed.
- (5) Loosen the screw fixing the line flow fan.
- (6) Remove the motor bed together with fan motor and motor band.
- (7) Remove the screw of the motor band.
- (8) Release the hooks of the motor band. Remove the motor band. Pull out the indoor fan motor.
- (9) Remove the indoor coil thermistor from the heat exchanger.  
\*Install the indoor coil thermistor in its former position when assembling it. (Photo 9)
- (10) Remove the screws fixing the left side of the heat exchanger.
- (11) Lift the heat exchanger, and pull out the line flow fan to the lower-left.

**Photo 7**

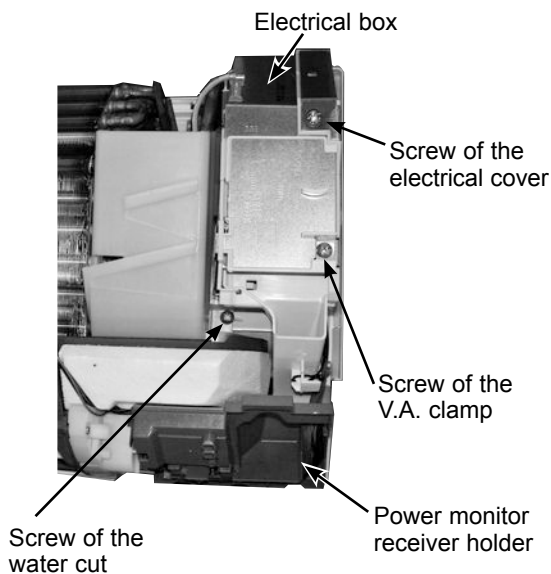

## PHOTOS

**Photo 8**

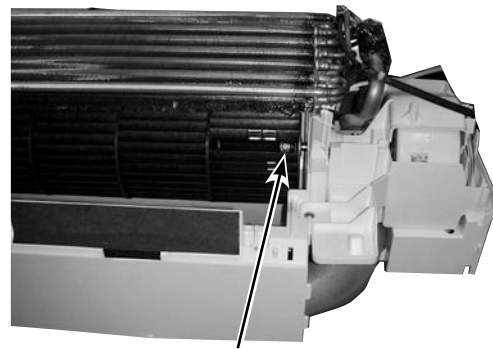

Screw of the line flow fan

**Photo 9**

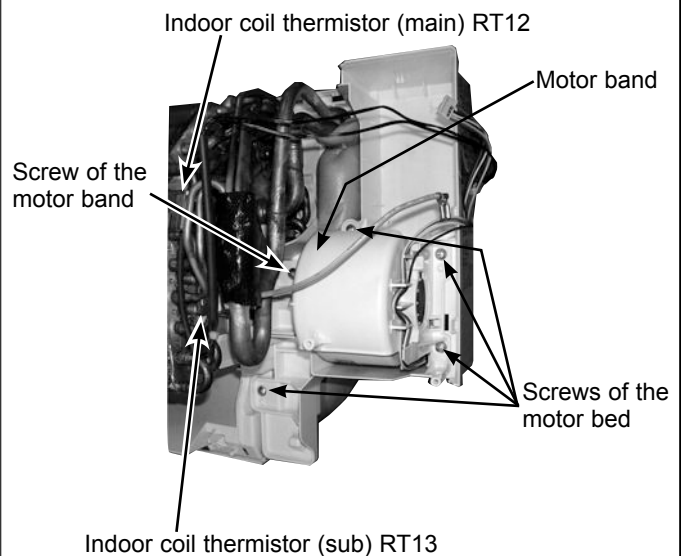

**Photo 10**

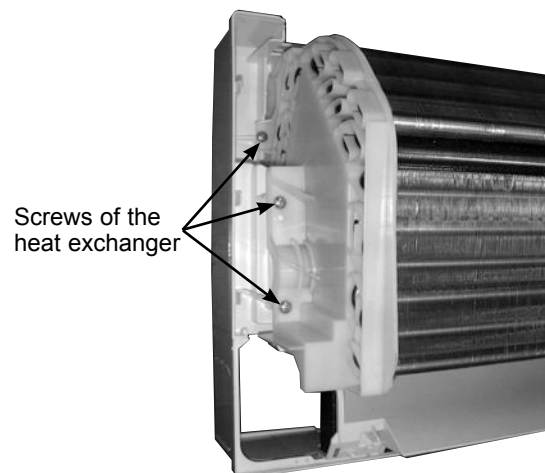





© Copyright 2008 MITSUBISHI ELECTRIC CO., LTD  
Distributed in Jun. 2010. No. OBH515 REVISED EDITION-E 5  
Distributed in Mar. 2010. No. OBH515 REVISED EDITION-D 5  
Distributed in Oct. 2009. No. OBH515 REVISED EDITION-C 5  
Distributed in Dec. 2008. No. OBH515 REVISED EDITION-B 5  
Distributed in Sep. 2008. No. OBH515 REVISED EDITION-A 5  
Distributed in Aug. 2008. No. OBH515 6  
Made in Japan

New publication, effective Jun. 2010  
Specifications subject to change without notice.