

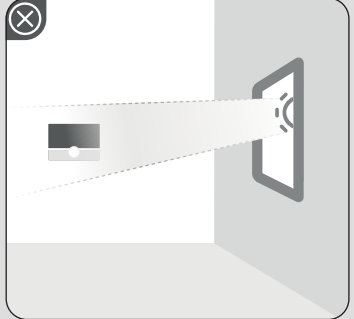

7857651-07 20/03/2025

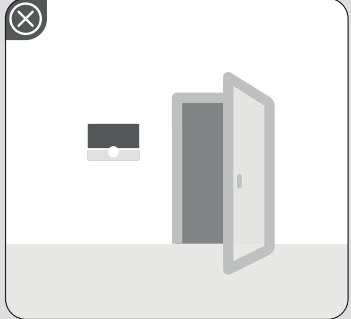

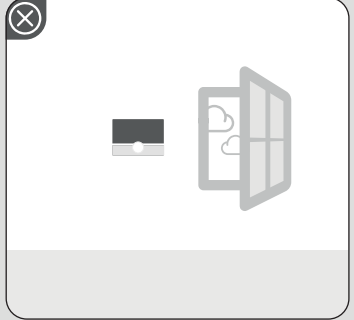
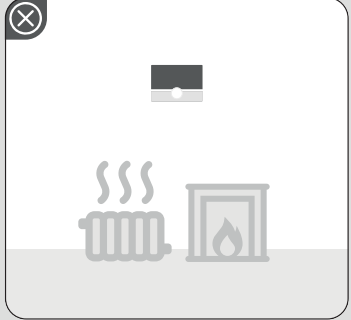
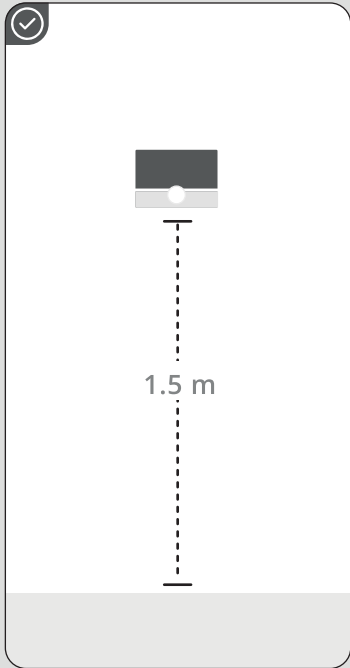
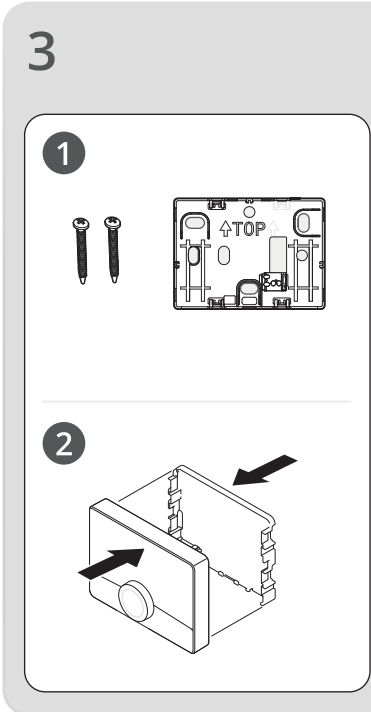
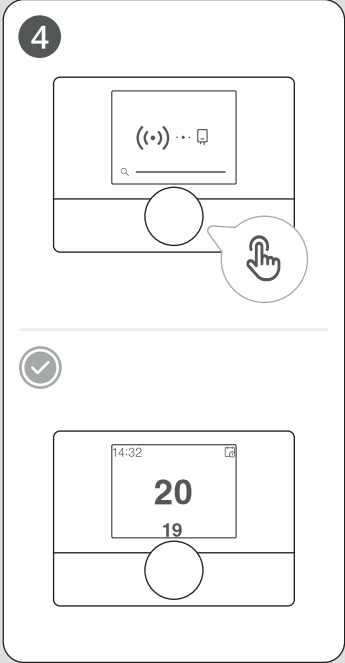
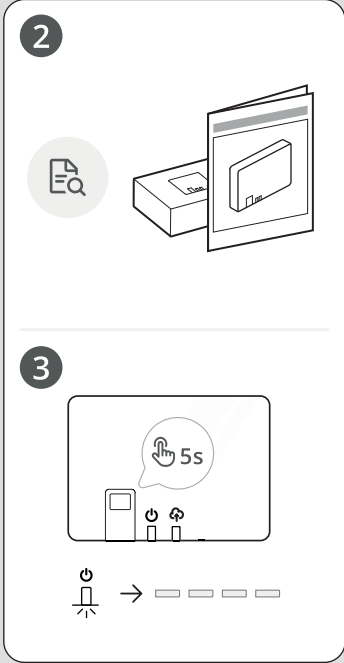
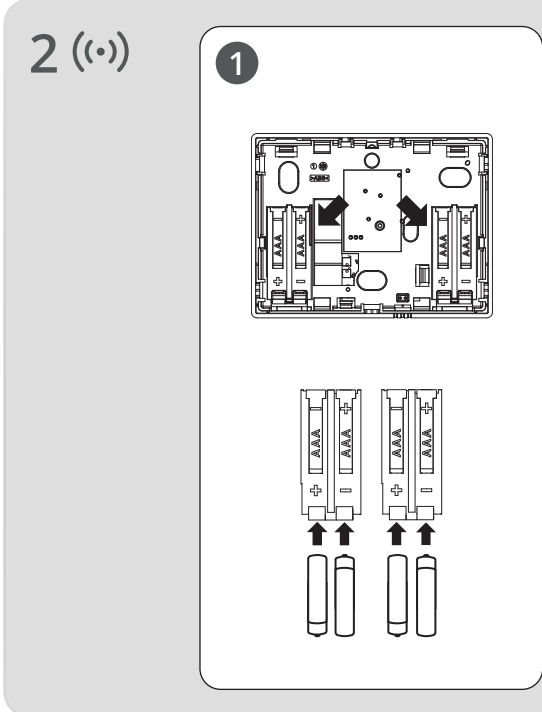
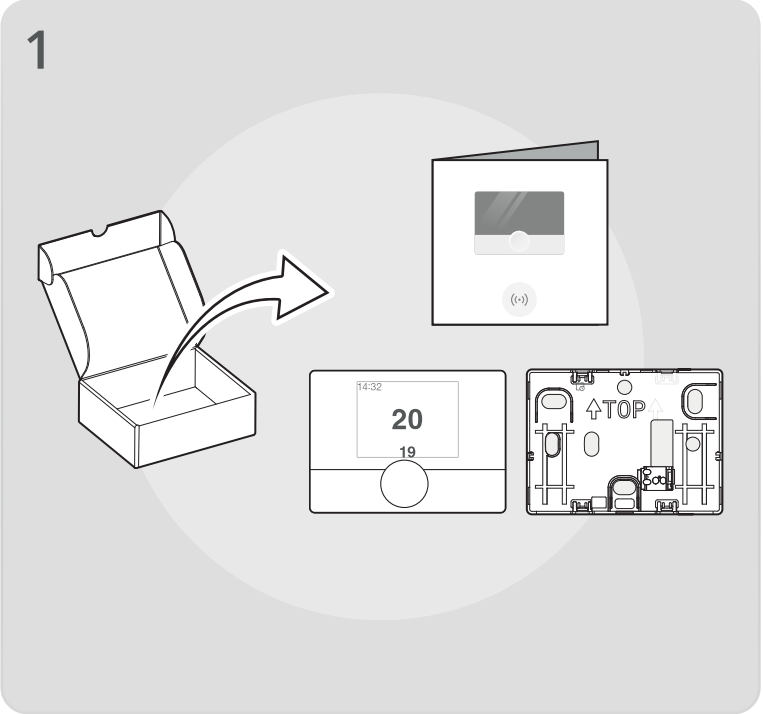
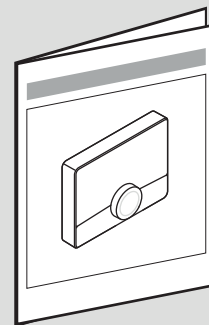

- Only use 4 batteries of identical age, type, and brand.
- Remove all batteries when the device is out of use.
- The device complies with RF exposure guidelines as long as it is at a distance of 20 cm from any persons.

Google Play and the Google Play logo are trademarks of Google LLC.

Apple and theApple logo are trademarks of Apple Inc.

Hereby, BDRThermea Group B.V. declares that the equipment type ARU is in compliance with Directive 2014/53/EU and S.I. 2017/1206. The full text of the EU and UK declaration of conformity is available at the following address: <https://declaration-of-conformity.bdrthermeagroup.com>

Max. output power	16.7 dBm
Frequency	2400-2483.5 MHz

