

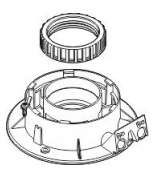



**PRODUCTO**  
**CALDERAS DE GAS**  
**CALDERAS MURALES DE CONDENSACION**  
**PLATINUM MAX IPLUS**  
**PLATINUM MAX IPLUS 35/35 F**





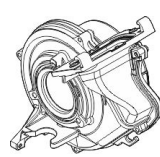
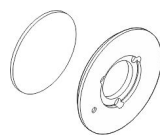

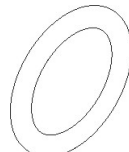
**BAXI**

**7783788**      **0000**      **PLATINUM MAX IPLUS 35/35F**  
**ESPAÑA**

	Nº	código	Descripción	Precio €
	<b>004</b>	<b>7784185</b>	PANEL FRONTAL PLATINUM MAX iPLUS Desde 01/02/2021      Hasta 31/12/2023	76,00
	<b>010</b>	<b>7784186</b>	ADAPTADOR SALIDA HUMOS PLATINUM MAX iPLUS Desde 01/02/2021      Hasta 31/12/2023	24,10
	<b>018</b>	<b>7784193</b>	VENTURI PLATINUM MAX iPLUS 24/24-30/30 Desde 01/02/2021      Hasta 31/12/2023	22,85
	<b>022</b>	<b>7784217</b>	VENTILADOR PLATINUM MAX iPLUS Desde 01/02/2021      Hasta 31/12/2023	413,15
	<b>029</b>	<b>7784194</b>	AISLANTE INTERCAMBIADOR PLATINUM MAX iPLUS Desde 01/02/2021      Hasta 31/12/2023	52,90
	<b>032</b>	<b>7784187</b>	INTERCAMBIADOR PLATINUM iMAX PLUS 35/35 Desde 01/02/2021      Hasta 31/12/2023	482,65
	<b>033</b>	<b>7648409</b>	JUNTA TÓRICA 21,5X3 VICTORIA CONDENS (10 uds) Desde 01/02/2021      Hasta 31/12/2023	5,00



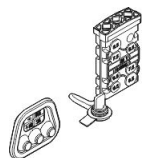

**PRODUCTO**  
**CALDERAS DE GAS**  
**CALDERAS MURALES DE CONDENSACION**  
**PLATINUM MAX IPLUS**  
**PLATINUM MAX IPLUS 35/35 F**

**BAXI**

	Nº	código	Descripción	Precio €
	<b>034</b>	<b>125838086</b>	CLIP FIJACIÓN TUBO NOVADENS/PLATINUM COMPACT	7,90
		Desde	01/02/2021	Hasta 99/99/9999
	<b>035</b>	<b>7784199</b>	VASO EXPANSION PLATINUM MAX iPLUS	89,70
		Desde	01/02/2021	Hasta 31/12/2023
	<b>036</b>	<b>7784218</b>	TUBO VASO EXPANSION PLATINUM MAX iPLUS	18,05
		Desde	01/02/2021	Hasta 31/12/2023
	<b>048</b>	<b>7784191</b>	COLECTOR SIFON PLATINUM MAX iPLUS	43,50
		Desde	01/02/2021	Hasta 31/12/2023
	<b>049</b>	<b>7784203</b>	TAPON ADAPTADOR SALIDA HUMOS PLATINUM MAX iPLUS	5,45
		Desde	01/02/2021	Hasta 31/12/2023
	<b>060</b>	<b>7784453</b>	PASACABLES PLATINUM MAX iPLUS	8,90
		Desde	01/02/2021	Hasta 31/12/2023
	<b>063</b>	<b>7784188</b>	ELECTRODO PLATINUM MAX iPLUS/NEODENS LITE	25,35
		Desde	01/02/2021	Hasta 31/12/2023
	<b>070</b>	<b>7784202</b>	CODO BOMBA PLATINUM MAX iPLUS	8,15
		Desde	01/02/2021	Hasta 31/12/2023

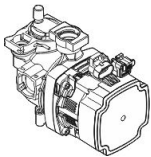
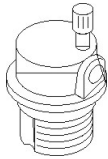

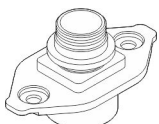

**PRODUCTO**  
**CALDERAS DE GAS**  
**CALDERAS MURALES DE CONDENSACION**  
**PLATINUM MAX IPLUS**  
**PLATINUM MAX IPLUS 35/35 F**

**BAXI**

	Nº	código	Descripción	Precio €
	<b>072</b>	<b>7784198</b>	BOMBA PLATINUM MAX iPLUS	197,85
		Desde	01/02/2021	Hasta 31/12/2023
	<b>073</b>	<b>125493600</b>	PURGADOR PLATINUM COMPACT (GRUNFOS)	35,65
		Desde	01/02/2021	Hasta 31/12/2023
	<b>075</b>	<b>125540924</b>	JUNTA PASAMUROS Ø10 BIOS	5,60
		Desde	01/02/2021	Hasta 99/99/9999
	<b>076</b>	<b>7218512</b>	INTERCAMBIADOR PLACAS NOVANOX28-MAX31 PLAT COM-PLUS28 v.01	133,60
		Desde	01/02/2021	Hasta 31/12/2023
	<b>077</b>	<b>7218516</b>	JUNTAS INTERCAMBIADOR NOVANOX-MAX PLAT COM-PLUS v.01 (4 uds)	4,40
		Desde	01/02/2021	Hasta 31/12/2023
	<b>080</b>	<b>7784189</b>	GRIFO RETORNO PLATINUM MAX iPLUS 24/24-30/30	88,95
		Desde	01/02/2021	Hasta 31/12/2023
	<b>081</b>	<b>7784204</b>	CARTUCHO GRIFO RETORNO PLATINUM MAX iPLUS 24/24-30/30	47,60
		Desde	01/02/2021	Hasta 31/12/2023
	<b>087</b>	<b>7784192</b>	RACORD BOMBA PLATINUM MAX iPLUS	13,20
		Desde	01/02/2021	Hasta 31/12/2023

**PRODUCTO**  
**CALDERAS DE GAS**  
**CALDERAS MURALES DE CONDENSACION**  
**PLATINUM MAX IPLUS**  
**PLATINUM MAX IPLUS 35/35 F**

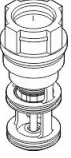
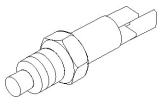
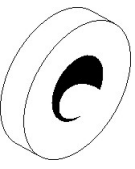
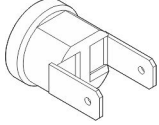
**BAXI**

	Nº	código	Descripción	Precio €
	<b>090</b>	<b>7784208</b>	GRIFO LLENADO PLATINUM MAX iPLUS	58,30
		Desde	01/02/2021	Hasta 99/99/9999
	<b>092</b>	<b>7784205</b>	VALVULA SEGURIDAD PLATINUM MAX iPLUS	11,15
		Desde	01/02/2021	Hasta 31/12/2023
	<b>102</b>	<b>7784219</b>	V3V PLATINUM MAX iPLUS	91,15
		Desde	01/02/2021	Hasta 31/12/2023
	<b>120</b>	<b>7784195</b>	CARTUCHO V3V PLATINUM MAX iPLUS	74,50
		Desde	01/02/2021	Hasta 31/12/2023
	<b>131</b>	<b>125843540</b>	SONDA NTC BIOS/NEOBIT PLUS/PLATINUM COMPACT	9,90
		Desde	01/02/2021	Hasta 31/12/2023
	<b>132</b>	<b>125540283</b>	JUNTA SONDA NTC ALTAIS/DEIMOS (5 uds)	6,05
		Desde	01/02/2021	Hasta 99/99/9999
	<b>135</b>	<b>7784220</b>	TERMOSTATO HUMOS PLATINUM MAX iPLUS	6,45
		Desde	01/02/2021	Hasta 31/12/2023
	<b>136</b>	<b>7784207</b>	TUBO IDA PLATINUM MAX iPLUS	22,90
		Desde	01/02/2021	Hasta 31/12/2023



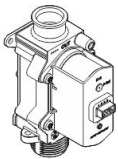
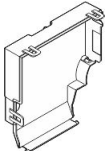
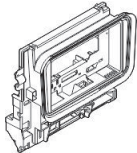
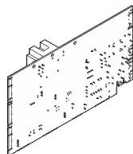
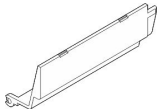
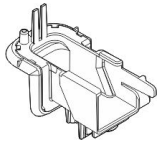
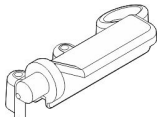

**PRODUCTO**  
**CALDERAS DE GAS**  
**CALDERAS MURALES DE CONDENSACION**  
**PLATINUM MAX IPLUS**  
**PLATINUM MAX IPLUS 35/35 F**

**BAXI**

	Nº	código	Descripción	Precio €
	139	7784243	TUBO GAS PLATINUM MAX iPLUS	31,60
			Desde 01/02/2021 Hasta 31/12/2023	
	140	7784210	VALVULA GAS PLATINUM MAX iPLUS	73,85
			Desde 01/02/2021 Hasta 31/12/2023	
	151	7784234	TAPA TRASERA CUADRO PLATINUM MAX iPLUS	20,00
			Desde 01/02/2021 Hasta 31/12/2023	
	152	7784250	TAPA FRONTAL CUADRO PLATINUM MAX iPLUS	24,95
			Desde 01/02/2021 Hasta 31/12/2023	
	154	7784212	TARJETA PLATINUM MAX iPLUS	202,20
			Desde 01/02/2021 Hasta 31/12/2023	
	157	7784242	TAPA CONEXIONES PLATINUM MAX iPLUS	7,50
			Desde 01/02/2021 Hasta 31/12/2023	
	159	7784209	SOPORTE SIFON PLATINUM MAX iPLUS	4,00
			Desde 01/02/2021 Hasta 31/12/2023	
	160	7784233	SOPORTE DERECHO CUADRO PLATINUM MAX iPLUS	5,00
			Desde 01/02/2021 Hasta 31/12/2023	

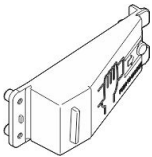

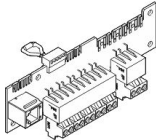
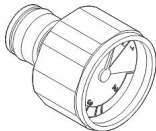
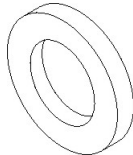
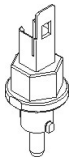
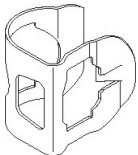

**PRODUCTO**  
**CALDERAS DE GAS**  
**CALDERAS MURALES DE CONDENSACION**  
**PLATINUM MAX IPLUS**  
**PLATINUM MAX IPLUS 35/35 F**

**BAXI**

	Nº	código	Descripción	Precio €
	161	7784237	SOPORTE CUADRO PLATINUM MAX iPLUS	5,20
		Desde	01/02/2021 Hasta 31/12/2023	
	162	7784211	EMBELLECEDOR PLATINUM MAX iPLUS	3,75
		Desde	01/02/2021 Hasta 31/12/2023	
	166	7784222	TARJETA CONEXIONES PLATINUM MAX iPLUS	33,10
		Desde	01/02/2021 Hasta 31/12/2023	
	169	7784214	MANOMETRO PLATINUM MAX iPLUS	14,20
		Desde	01/02/2021 Hasta 31/12/2023	
	192	125540465	JUNTA G 3/4 17X24X2 ALTA/DEIMOS/NEOBIT PL/ PLATINUM C (5 uds)	9,80
		Desde	01/02/2021 Hasta 99/99/9999	
	242	7648432	SONDA NTC VICTORIA CONDENS	22,75
		Desde	01/02/2021 Hasta 31/12/2023	
	322	7648433	CLIP TERMOSTATO VICTORIA CONDENS	3,50
		Desde	01/02/2021 Hasta 31/12/2023	
	336	125838068	MUELLE FIJACIÓN MOTOR ALTAIS/DEIMOS/ PLATINUM COMPACT	5,60
		Desde	01/02/2021 Hasta 99/99/9999	

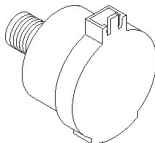
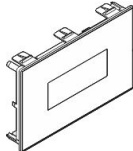
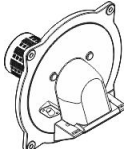
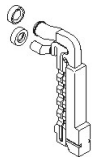



**PRODUCTO**  
**CALDERAS DE GAS**  
**CALDERAS MURALES DE CONDENSACION**  
**PLATINUM MAX IPLUS**  
**PLATINUM MAX IPLUS 35/35 F**

**BAXI**

	Nº	código	Descripción	Precio €
	<b>337</b>	<b>7784213</b>	MOTOR V3V PLATINUM MAX iPLUS	26,95
		Desde	01/02/2021	Hasta 31/12/2023
	<b>340</b>	<b>125109100</b>	SENSOR PRESIÓN PLATINUM COMPACT/POWER HT PLUS	27,25
		Desde	01/02/2021	Hasta 31/12/2023
	<b>347</b>	<b>7784221</b>	CUADRO CONTROL PLATINUM MAX iPLUS	232,50
		Desde	01/02/2021	Hasta 31/12/2023
	<b>408</b>	<b>7784228</b>	TAPA INTERCAMBIADOR PLATINUM MAX iPLUS	106,50
		Desde	01/02/2021	Hasta 31/12/2023
	<b>415</b>	<b>7648435</b>	SIFON VICTORIA CONDENS	22,55
		Desde	01/02/2021	Hasta 31/12/2023
	<b>419</b>	<b>7648442</b>	JUNTA TAPA INTERCAMBIADOR VICTORIA CONDENS	14,15
		Desde	01/02/2021	Hasta 31/12/2023
	<b>425</b>	<b>7784236</b>	JUNTA VENTURI PLATINUM MAX iPLUS	3,10
		Desde	01/02/2021	Hasta 31/12/2023
	<b>432</b>	<b>7784223</b>	JUNTA ADAPTADOR HUMOS PLATINUM MAX iPLUS	5,80
		Desde	01/02/2021	Hasta 31/12/2023



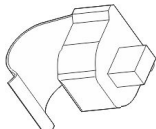
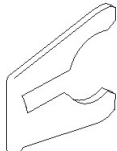
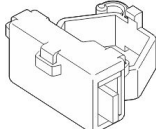
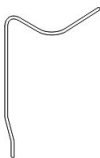



**PRODUCTO**  
**CALDERAS DE GAS**  
**CALDERAS MURALES DE CONDENSACION**  
**PLATINUM MAX IPLUS**  
**PLATINUM MAX IPLUS 35/35 F**

**BAXI**

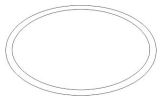
	Nº	código	Descripción	Precio €
	<b>434</b>	<b>7784229</b>	BANDEJA CONDENSADOS PLATINUM MAX iPLUS	4,50
		Desde	01/02/2021	Hasta 31/12/2023
	<b>511</b>	<b>125540460</b>	JUNTA TÓRICA ALTAIS/DEIMOS/NEOBIT PL/ PLATINUM C (5 uds)	10,05
		Desde	01/02/2021	Hasta 31/12/2023
	<b>528</b>	<b>7669016</b>	SONDA NTC VICTORIA CONDENS	6,55
		Desde	01/02/2021	Hasta 31/12/2023
	<b>600</b>	<b>125045401</b>	CLIP Ø18 NEOBIT PLUS	6,80
		Desde	01/02/2021	Hasta 31/12/2023
	<b>624</b>	<b>7784231</b>	SENSOR DETECTOR CAUDAL PLATINUM MAX iPLUS	10,60
		Desde	01/02/2021	Hasta 31/12/2023
	<b>673</b>	<b>7784235</b>	TUBO RECOGIDA CONDENSADOS PLATINUM MAX iPLUS	6,35
		Desde	01/02/2021	Hasta 31/12/2023
	<b>681</b>	<b>7648443</b>	JUNTA ELECTRODO VICTORIA CONDENS	5,90
		Desde	01/02/2021	Hasta 31/12/2023
	<b>683</b>	<b>7784224</b>	JUNTA SIFON-VALVULA SEGURIDAD PLATINUM MAX iPLUS	3,30
		Desde	01/02/2021	Hasta 31/12/2023

**PRODUCTO**  
**CALDERAS DE GAS**  
**CALDERAS MURALES DE CONDENSACION**  
**PLATINUM MAX IPLUS**  
**PLATINUM MAX IPLUS 35/35 F**

**BAXI**

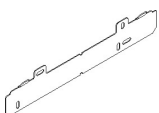
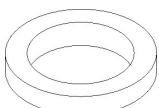
	Nº	código	Descripción	Precio €
	710	7660428	JUNTA Ø60 INTERCAMBIADOR VICTORIA CONDENS	9,00
			Desde 01/02/2021 Hasta 31/12/2023	
	718	7784241	TUBO BOMBA-INTERCAMBIADOR PLATINUM MAX iPLUS	24,75
			Desde 01/02/2021 Hasta 31/12/2023	
	746	7784232	JUNTA VENTILADOR-TAPA INTERCAMBIADOR PLATINUM MAX iPLUS	3,30
			Desde 01/02/2021 Hasta 31/12/2023	
	764	7784225	CLIP Ø21 PLATINUM MAX iPLUS (5UD)	8,60
			Desde 01/02/2021 Hasta 31/12/2023	
	765	125045700	JUNTA TÓRICA Ø9,19x2,62 PLATINUM COMPACT (10 uds)	6,90
			Desde 01/02/2021 Hasta 31/12/2023	
	766	7784240	CLIP Ø17,5 PLATINUM MAX iPLUS (5UD)	9,05
			Desde 01/02/2021 Hasta 31/12/2023	
	780	7648444	TRAVIESA SUPERIOR VICTORIA CONDENS	13,35
			Desde 01/02/2021 Hasta 31/12/2023	
	783	125039500	JUNTA VÁLVULA DE GAS PLATINUM COMPACT (10uds)	5,40
			Desde 01/02/2021 Hasta 99/99/9999	

**PRODUCTO**  
**CALDERAS DE GAS**  
**CALDERAS MURALES DE CONDENSACION**  
**PLATINUM MAX IPLUS**  
**PLATINUM MAX IPLUS 35/35 F**

**BAXI**

	Nº	código	Descripción	Precio €
	<b>785</b>	<b>7784246</b>	JUNTA INYECTOR PLATINUM MAX iPLUS (5UD)	14,65
		Desde	01/02/2021	Hasta 31/12/2023
	<b>786</b>	<b>7784226</b>	JUNTA VALVULA SEGURIDAD PLATINUM MAX iPLUS (5UD)	12,25
		Desde	01/02/2021	Hasta 31/12/2023
	<b>787</b>	<b>7784249</b>	JUNTA CUADRO PLATINUM MAX iPLUS	5,90
		Desde	01/02/2021	Hasta 31/12/2023
	<b>791</b>	<b>7648451</b>	JUNTA SIFON VICTORIA CONDENS	8,65
		Desde	01/02/2021	Hasta 31/12/2023
	<b>792</b>	<b>7784239</b>	JUNTA COLECTOR SIFON PLATINUM MAX iPLUS	3,45
		Desde	01/02/2021	Hasta 31/12/2023
	<b>799</b>	<b>125654100</b>	MUELLE FIJACIÓN Ø9 PLATINUM COMPACT	4,60
		Desde	01/02/2021	Hasta 31/12/2023
	<b>805</b>	<b>7784245</b>	CSU PLATINUM MAX iPLUS	11,95
		Desde	01/02/2021	Hasta 31/12/2023
	<b>806</b>	<b>7648446</b>	CLIP Ø10 VICTORIA CONDENS (5 uds)	5,00
		Desde	01/02/2021	Hasta 31/12/2023

**PRODUCTO**  
**CALDERAS DE GAS**  
**CALDERAS MURALES DE CONDENSACION**  
**PLATINUM MAX IPLUS**  
**PLATINUM MAX IPLUS 35/35 F**

**BAXI**

Nº	código	Descripción	Precio €
809	7218119	CLIP VÁLVULA SEGURIDAD NOVANOX (5 uds)	5,75
		Desde 01/02/2021 Hasta 31/12/2023	
812	7784248	TAPON AIRE PLATINUM MAX iPLUS	4,05
		Desde 01/02/2021 Hasta 99/99/9999	
818	7784227	JUNTA 14X3 PLATINUM MAX iPLUS (10UD)	11,90
		Desde 01/02/2021 Hasta 31/12/2023	
999	7784244	CABLE BOMBA/V3V PLATINUM MAX iPLUS	23,45
		Desde 01/02/2021 Hasta 31/12/2023	
999	7784230	CABLE VENTILADOR PLATINUM MAX iPLUS	18,50
		Desde 01/02/2021 Hasta 31/12/2023	
999	7784251	CABLE BAJA TENSION PLATINUM MAX iPLUS	52,65
		Desde 01/02/2021 Hasta 31/12/2023	
999	7784238	CABLE TARJETA CB PLATINUM MAX iPLUS	17,90
		Desde 01/02/2021 Hasta 31/12/2023	
999	7784247	CABLE ELECTRODO PLATINUM MAX iPLUS	15,55
		Desde 01/02/2021 Hasta 31/12/2023	

