

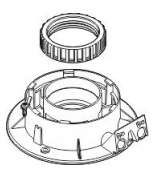



PRODUCTO
CALDERAS DE GAS
CALDERAS MURALES DE CONDENSACION
PLATINUM MAX IPLUS
PLATINUM MAX IPLUS 30/30 F





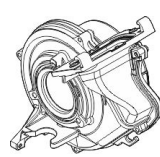
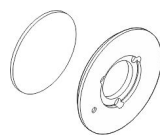

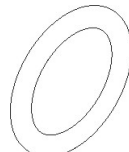
BAXI

7783787 **0000** **PLATINUM MAX IPLUS 30/30F**
ESPAÑA

| | Nº | código | Descripción | Precio € |
|---|------------|----------------|---|----------|
|  | 004 | 7784185 | PANEL FRONTAL PLATINUM MAX iPLUS Desde 01/02/2021 Hasta 31/12/2023 | 76,00 |
|  | 010 | 7784186 | ADAPTADOR SALIDA HUMOS PLATINUM MAX iPLUS Desde 01/02/2021 Hasta 31/12/2023 | 24,10 |
|  | 018 | 7784193 | VENTURI PLATINUM MAX iPLUS 24/24-30/30 Desde 01/02/2021 Hasta 31/12/2023 | 22,85 |
|  | 022 | 7784217 | VENTILADOR PLATINUM MAX iPLUS Desde 01/02/2021 Hasta 31/12/2023 | 413,15 |
|  | 029 | 7784194 | AISLANTE INTERCAMBIADOR PLATINUM MAX iPLUS Desde 01/02/2021 Hasta 31/12/2023 | 52,90 |
|  | 032 | 7784200 | INTERCAMBIADOR PLATINUM iMAX PLUS 24/24-30/30 Desde 01/02/2021 Hasta 31/12/2023 | 425,35 |
|  | 033 | 7648409 | JUNTA TÓRICA 21,5X3 VICTORIA CONDENS (10 uds) Desde 01/02/2021 Hasta 31/12/2023 | 5,00 |



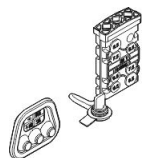

PRODUCTO
CALDERAS DE GAS
CALDERAS MURALES DE CONDENSACION
PLATINUM MAX IPLUS
PLATINUM MAX IPLUS 30/30 F

BAXI

| | Nº | código | Descripción | Precio € |
|---|------------|------------------|---|------------------|
|  | 034 | 125838086 | CLIP FIJACIÓN TUBO NOVADENS/PLATINUM COMPACT | 7,90 |
| | | Desde | 01/02/2021 | Hasta 99/99/9999 |
|  | 035 | 7784199 | VASO EXPANSION PLATINUM MAX iPLUS | 89,70 |
| | | Desde | 01/02/2021 | Hasta 31/12/2023 |
|  | 036 | 7784218 | TUBO VASO EXPANSION PLATINUM MAX iPLUS | 18,05 |
| | | Desde | 01/02/2021 | Hasta 31/12/2023 |
|  | 048 | 7784191 | COLECTOR SIFON PLATINUM MAX iPLUS | 43,50 |
| | | Desde | 01/02/2021 | Hasta 31/12/2023 |
|  | 049 | 7784203 | TAPON ADAPTADOR SALIDA HUMOS PLATINUM MAX iPLUS | 5,45 |
| | | Desde | 01/02/2021 | Hasta 31/12/2023 |
|  | 060 | 7784453 | PASACABLES PLATINUM MAX iPLUS | 8,90 |
| | | Desde | 01/02/2021 | Hasta 31/12/2023 |
|  | 063 | 7784188 | ELECTRODO PLATINUM MAX iPLUS/NEODENS LITE | 25,35 |
| | | Desde | 01/02/2021 | Hasta 31/12/2023 |
|  | 070 | 7784202 | CODO BOMBA PLATINUM MAX iPLUS | 8,15 |
| | | Desde | 01/02/2021 | Hasta 31/12/2023 |

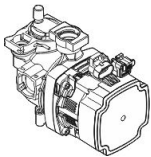
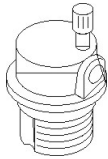

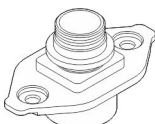

PRODUCTO
CALDERAS DE GAS
CALDERAS MURALES DE CONDENSACION
PLATINUM MAX IPLUS
PLATINUM MAX IPLUS 30/30 F

BAXI

| | Nº | código | Descripción | Precio € |
|---|------------|------------------|---|------------------|
|  | 072 | 7784198 | BOMBA PLATINUM MAX iPLUS | 197,85 |
| | | Desde | 01/02/2021 | Hasta 31/12/2023 |
|  | 073 | 125493600 | PURGADOR PLATINUM COMPACT (GRUNFOS) | 35,65 |
| | | Desde | 01/02/2021 | Hasta 31/12/2023 |
|  | 075 | 125540924 | JUNTA PASAMUROS Ø10 BIOS | 5,60 |
| | | Desde | 01/02/2021 | Hasta 99/99/9999 |
| | 076 | 7218510 | INTERCAMBIADOR PLACAS NOV.24-MAX25 PLAT COM-PLUS24 v01 | 137,90 |
| | | Desde | 01/02/2021 | Hasta 31/12/2023 |
| | 077 | 7218516 | JUNTAS INTERCAMBIADOR NOVANOX-MAX PLAT COM-PLUS v.01 (4 uds) | 4,40 |
| | | Desde | 01/02/2021 | Hasta 31/12/2023 |
|  | 080 | 7784189 | GRIFO RETORNO PLATINUM MAX iPLUS 24/24-30/30 | 88,95 |
| | | Desde | 01/02/2021 | Hasta 31/12/2023 |
|  | 081 | 7784204 | CARTUCHO GRIFO RETORNO PLATINUM MAX iPLUS 24/24-30/30 | 47,60 |
| | | Desde | 01/02/2021 | Hasta 31/12/2023 |
|  | 087 | 7784192 | RACORD BOMBA PLATINUM MAX iPLUS | 13,20 |
| | | Desde | 01/02/2021 | Hasta 31/12/2023 |

PRODUCTO
CALDERAS DE GAS
CALDERAS MURALES DE CONDENSACION
PLATINUM MAX IPLUS
PLATINUM MAX IPLUS 30/30 F

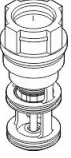
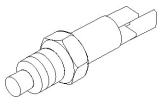
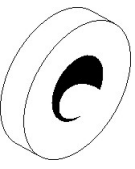
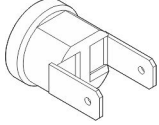
BAXI

| | Nº | código | Descripción | Precio € |
|---|------------|------------------|---|------------------|
|  | 090 | 7784208 | GRIFO LLENADO PLATINUM MAX iPLUS | 58,30 |
| | | Desde | 01/02/2021 | Hasta 99/99/9999 |
|  | 092 | 7784205 | VALVULA SEGURIDAD PLATINUM MAX iPLUS | 11,15 |
| | | Desde | 01/02/2021 | Hasta 31/12/2023 |
|  | 102 | 7784219 | V3V PLATINUM MAX iPLUS | 91,15 |
| | | Desde | 01/02/2021 | Hasta 31/12/2023 |
|  | 120 | 7784195 | CARTUCHO V3V PLATINUM MAX iPLUS | 74,50 |
| | | Desde | 01/02/2021 | Hasta 31/12/2023 |
|  | 131 | 125843540 | SONDA NTC BIOS/NEOBIT PLUS/PLATINUM COMPACT | 9,90 |
| | | Desde | 01/02/2021 | Hasta 31/12/2023 |
|  | 132 | 125540283 | JUNTA SONDA NTC ALTAIS/DEIMOS (5 uds) | 6,05 |
| | | Desde | 01/02/2021 | Hasta 99/99/9999 |
|  | 135 | 7784220 | TERMOSTATO HUMOS PLATINUM MAX iPLUS | 6,45 |
| | | Desde | 01/02/2021 | Hasta 31/12/2023 |
|  | 136 | 7784207 | TUBO IDA PLATINUM MAX iPLUS | 22,90 |
| | | Desde | 01/02/2021 | Hasta 31/12/2023 |



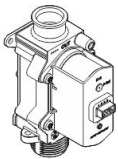
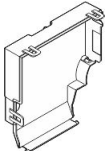
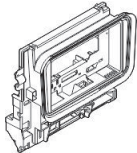
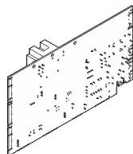
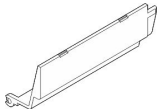
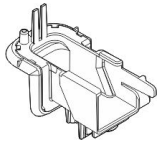
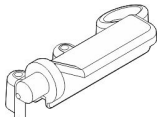

PRODUCTO
CALDERAS DE GAS
CALDERAS MURALES DE CONDENSACION
PLATINUM MAX IPLUS
PLATINUM MAX IPLUS 30/30 F

BAXI

| | Nº | código | Descripción | Precio € |
|---|-----|---------|---|----------|
|  | 139 | 7784243 | TUBO GAS PLATINUM MAX iPLUS | 31,60 |
| | | | Desde 01/02/2021 Hasta 31/12/2023 | |
|  | 140 | 7784210 | VALVULA GAS PLATINUM MAX iPLUS | 73,85 |
| | | | Desde 01/02/2021 Hasta 31/12/2023 | |
|  | 151 | 7784234 | TAPA TRASERA CUADRO PLATINUM MAX iPLUS | 20,00 |
| | | | Desde 01/02/2021 Hasta 31/12/2023 | |
|  | 152 | 7784250 | TAPA FRONTAL CUADRO PLATINUM MAX iPLUS | 24,95 |
| | | | Desde 01/02/2021 Hasta 31/12/2023 | |
|  | 154 | 7784212 | TARJETA PLATINUM MAX iPLUS | 202,20 |
| | | | Desde 01/02/2021 Hasta 31/12/2023 | |
|  | 157 | 7784242 | TAPA CONEXIONES PLATINUM MAX iPLUS | 7,50 |
| | | | Desde 01/02/2021 Hasta 31/12/2023 | |
|  | 159 | 7784209 | SOPORTE SIFON PLATINUM MAX iPLUS | 4,00 |
| | | | Desde 01/02/2021 Hasta 31/12/2023 | |
|  | 160 | 7784233 | SOPORTE DERECHO CUADRO PLATINUM MAX iPLUS | 5,00 |
| | | | Desde 01/02/2021 Hasta 31/12/2023 | |

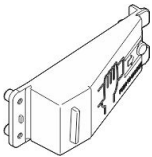

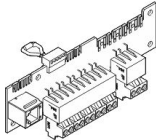
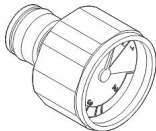
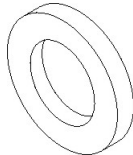
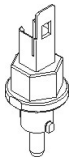
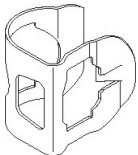

PRODUCTO
CALDERAS DE GAS
CALDERAS MURALES DE CONDENSACION
PLATINUM MAX IPLUS
PLATINUM MAX IPLUS 30/30 F

BAXI

| | Nº | código | Descripción | Precio € |
|---|-----|-----------|--|----------|
|  | 161 | 7784237 | SOPORTE CUADRO PLATINUM MAX iPLUS | 5,20 |
| | | Desde | 01/02/2021 Hasta 31/12/2023 | |
|  | 162 | 7784211 | EMBELLECEDOR PLATINUM MAX iPLUS | 3,75 |
| | | Desde | 01/02/2021 Hasta 31/12/2023 | |
|  | 166 | 7784222 | TARJETA CONEXIONES PLATINUM MAX iPLUS | 33,10 |
| | | Desde | 01/02/2021 Hasta 31/12/2023 | |
|  | 169 | 7784214 | MANOMETRO PLATINUM MAX iPLUS | 14,20 |
| | | Desde | 01/02/2021 Hasta 31/12/2023 | |
|  | 192 | 125540465 | JUNTA G 3/4 17X24X2 ALTA/DEIMOS/NEOBIT PL/ PLATINUM C (5 uds) | 9,80 |
| | | Desde | 01/02/2021 Hasta 99/99/9999 | |
|  | 242 | 7648432 | SONDA NTC VICTORIA CONDENS | 22,75 |
| | | Desde | 01/02/2021 Hasta 31/12/2023 | |
|  | 322 | 7648433 | CLIP TERMOSTATO VICTORIA CONDENS | 3,50 |
| | | Desde | 01/02/2021 Hasta 31/12/2023 | |
|  | 336 | 125838068 | MUELLE FIJACIÓN MOTOR ALTAIS/DEIMOS/ PLATINUM COMPACT | 5,60 |
| | | Desde | 01/02/2021 Hasta 99/99/9999 | |

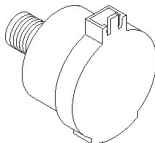
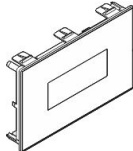
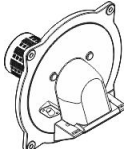
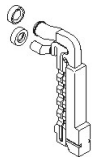



PRODUCTO
CALDERAS DE GAS
CALDERAS MURALES DE CONDENSACION
PLATINUM MAX IPLUS
PLATINUM MAX IPLUS 30/30 F

BAXI

| | Nº | código | Descripción | Precio € |
|---|------------|------------------|---|------------------|
|  | 337 | 7784213 | MOTOR V3V PLATINUM MAX iPLUS | 26,95 |
| | | Desde | 01/02/2021 | Hasta 31/12/2023 |
|  | 340 | 125109100 | SENSOR PRESIÓN PLATINUM COMPACT/POWER HT PLUS | 27,25 |
| | | Desde | 01/02/2021 | Hasta 31/12/2023 |
|  | 347 | 7784221 | CUADRO CONTROL PLATINUM MAX iPLUS | 232,50 |
| | | Desde | 01/02/2021 | Hasta 31/12/2023 |
|  | 408 | 7784228 | TAPA INTERCAMBIADOR PLATINUM MAX iPLUS | 106,50 |
| | | Desde | 01/02/2021 | Hasta 31/12/2023 |
|  | 415 | 7648435 | SIFON VICTORIA CONDENS | 22,55 |
| | | Desde | 01/02/2021 | Hasta 31/12/2023 |
|  | 419 | 7648442 | JUNTA TAPA INTERCAMBIADOR VICTORIA CONDENS | 14,15 |
| | | Desde | 01/02/2021 | Hasta 31/12/2023 |
|  | 425 | 7784236 | JUNTA VENTURI PLATINUM MAX iPLUS | 3,10 |
| | | Desde | 01/02/2021 | Hasta 31/12/2023 |
|  | 432 | 7784223 | JUNTA ADAPTADOR HUMOS PLATINUM MAX iPLUS | 5,80 |
| | | Desde | 01/02/2021 | Hasta 31/12/2023 |



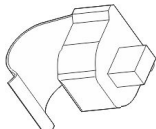
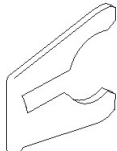
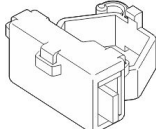
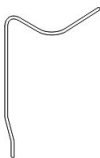



PRODUCTO
CALDERAS DE GAS
CALDERAS MURALES DE CONDENSACION
PLATINUM MAX IPLUS
PLATINUM MAX IPLUS 30/30 F

BAXI

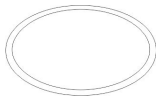
| | Nº | código | Descripción | Precio € |
|---|------------|------------------|---|------------------|
|  | 434 | 7784229 | BANDEJA CONDENSADOS PLATINUM MAX iPLUS | 4,50 |
| | | Desde | 01/02/2021 | Hasta 31/12/2023 |
|  | 511 | 125540460 | JUNTA TÓRICA ALTAIS/DEIMOS/NEOBIT PL/ PLATINUM C (5 uds) | 10,05 |
| | | Desde | 01/02/2021 | Hasta 31/12/2023 |
|  | 528 | 7669016 | SONDA NTC VICTORIA CONDENS | 6,55 |
| | | Desde | 01/02/2021 | Hasta 31/12/2023 |
|  | 600 | 125045401 | CLIP Ø18 NEOBIT PLUS | 6,80 |
| | | Desde | 01/02/2021 | Hasta 31/12/2023 |
|  | 624 | 7784231 | SENSOR DETECTOR CAUDAL PLATINUM MAX iPLUS | 10,60 |
| | | Desde | 01/02/2021 | Hasta 31/12/2023 |
|  | 673 | 7784235 | TUBO RECOGIDA CONDENSADOS PLATINUM MAX iPLUS | 6,35 |
| | | Desde | 01/02/2021 | Hasta 31/12/2023 |
|  | 681 | 7648443 | JUNTA ELECTRODO VICTORIA CONDENS | 5,90 |
| | | Desde | 01/02/2021 | Hasta 31/12/2023 |
|  | 683 | 7784224 | JUNTA SIFON-VALVULA SEGURIDAD PLATINUM MAX iPLUS | 3,30 |
| | | Desde | 01/02/2021 | Hasta 31/12/2023 |

PRODUCTO
CALDERAS DE GAS
CALDERAS MURALES DE CONDENSACION
PLATINUM MAX IPLUS
PLATINUM MAX IPLUS 30/30 F

BAXI

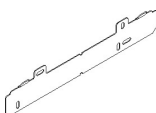
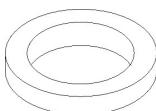
| | Nº | código | Descripción | Precio € |
|---|-----|-----------|---|----------|
|  | 710 | 7660428 | JUNTA Ø60 INTERCAMBIADOR VICTORIA CONDENS | 9,00 |
| | | | Desde 01/02/2021 Hasta 31/12/2023 | |
|  | 718 | 7784241 | TUBO BOMBA-INTERCAMBIADOR PLATINUM MAX iPLUS | 24,75 |
| | | | Desde 01/02/2021 Hasta 31/12/2023 | |
|  | 746 | 7784232 | JUNTA VENTILADOR-TAPA INTERCAMBIADOR PLATINUM MAX iPLUS | 3,30 |
| | | | Desde 01/02/2021 Hasta 31/12/2023 | |
|  | 764 | 7784225 | CLIP Ø21 PLATINUM MAX iPLUS (5UD) | 8,60 |
| | | | Desde 01/02/2021 Hasta 31/12/2023 | |
|  | 765 | 125045700 | JUNTA TÓRICA Ø9,19x2,62 PLATINUM COMPACT (10 uds) | 6,90 |
| | | | Desde 01/02/2021 Hasta 31/12/2023 | |
|  | 766 | 7784240 | CLIP Ø17,5 PLATINUM MAX iPLUS (5UD) | 9,05 |
| | | | Desde 01/02/2021 Hasta 31/12/2023 | |
|  | 780 | 7648444 | TRAVIESA SUPERIOR VICTORIA CONDENS | 13,35 |
| | | | Desde 01/02/2021 Hasta 31/12/2023 | |
|  | 783 | 125039500 | JUNTA VÁLVULA DE GAS PLATINUM COMPACT (10uds) | 5,40 |
| | | | Desde 01/02/2021 Hasta 99/99/9999 | |

PRODUCTO
CALDERAS DE GAS
CALDERAS MURALES DE CONDENSACION
PLATINUM MAX IPLUS
PLATINUM MAX IPLUS 30/30 F

BAXI

| | Nº | código | Descripción | Precio € |
|---|------------|------------------|--|------------------|
|  | 785 | 7784246 | JUNTA INYECTOR PLATINUM MAX iPLUS (5UD) | 14,65 |
| | | Desde | 01/02/2021 | Hasta 31/12/2023 |
|  | 786 | 7784226 | JUNTA VALVULA SEGURIDAD PLATINUM MAX iPLUS (5UD) | 12,25 |
| | | Desde | 01/02/2021 | Hasta 31/12/2023 |
|  | 787 | 7784249 | JUNTA CUADRO PLATINUM MAX iPLUS | 5,90 |
| | | Desde | 01/02/2021 | Hasta 31/12/2023 |
|  | 791 | 7648451 | JUNTA SIFON VICTORIA CONDENS | 8,65 |
| | | Desde | 01/02/2021 | Hasta 31/12/2023 |
|  | 792 | 7784239 | JUNTA COLECTOR SIFON PLATINUM MAX iPLUS | 3,45 |
| | | Desde | 01/02/2021 | Hasta 31/12/2023 |
|  | 799 | 125654100 | MUELLE FIJACIÓN Ø9 PLATINUM COMPACT | 4,60 |
| | | Desde | 01/02/2021 | Hasta 31/12/2023 |
|  | 805 | 7784245 | CSU PLATINUM MAX iPLUS | 11,95 |
| | | Desde | 01/02/2021 | Hasta 31/12/2023 |
|  | 806 | 7648446 | CLIP Ø10 VICTORIA CONDENS (5 uds) | 5,00 |
| | | Desde | 01/02/2021 | Hasta 31/12/2023 |

PRODUCTO
CALDERAS DE GAS
CALDERAS MURALES DE CONDENSACION
PLATINUM MAX IPLUS
PLATINUM MAX IPLUS 30/30 F

BAXI

| Nº | código | Descripción | Precio € |
|-----|---------|--|----------|
| 809 | 7218119 | CLIP VÁLVULA SEGURIDAD NOVANOX (5 uds) | 5,75 |
| | | Desde 01/02/2021 Hasta 31/12/2023 | |
| 812 | 7784248 | TAPON AIRE PLATINUM MAX iPLUS | 4,05 |
| | | Desde 01/02/2021 Hasta 99/99/9999 | |
| 818 | 7784227 | JUNTA 14X3 PLATINUM MAX iPLUS (10UD) | 11,90 |
| | | Desde 01/02/2021 Hasta 31/12/2023 | |
| 999 | 7784244 | CABLE BOMBA/V3V PLATINUM MAX iPLUS | 23,45 |
| | | Desde 01/02/2021 Hasta 31/12/2023 | |
| 999 | 7784230 | CABLE VENTILADOR PLATINUM MAX iPLUS | 18,50 |
| | | Desde 01/02/2021 Hasta 31/12/2023 | |
| 999 | 7784251 | CABLE BAJA TENSION PLATINUM MAX iPLUS | 52,65 |
| | | Desde 01/02/2021 Hasta 31/12/2023 | |
| 999 | 7784238 | CABLE TARJETA CB PLATINUM MAX iPLUS | 17,90 |
| | | Desde 01/02/2021 Hasta 31/12/2023 | |
| 999 | 7784247 | CABLE ELECTRODO PLATINUM MAX iPLUS | 15,55 |
| | | Desde 01/02/2021 Hasta 31/12/2023 | |

